

**SIEMENS**



# Betagard – Inspiring Safety

Answers for infrastructure.

[www.siemens.co.in](http://www.siemens.co.in)

# Low-Voltage Electrical Installation Technology

**Betagard Miniature Circuit Breakers & Betagard DC Circuit Breakers**



**Betagard Residual Current Devices**



**Betagard Distributions Boards**



**Betagard Automatic Transfer Switching Equipment - ATSE**



# Betagard Miniature Circuit Breakers & Betagard DC Circuit Breakers

All round protection guaranteed



4 Betagard 5SL MCBs

12 Betagard 5SX4 MCBs

18 Betagard DC Circuit Breakers

22 Betagard 5SP4 MCBs

24 Betagard Isolator

25 Accessories



# Betagard Miniature Circuit Breakers & DC Circuit Breakers

## Betagard 5SL MCBs

### Overview

As a culture Siemens has always endeavoured to introduce innovative products worldwide. The Electrical Installation R&D team has now raised the bar with the introduction of Betagard 5SL Miniature Circuit Breaker. Manufactured and designed at the Siemens Aurangabad facility, Betagard 5SL – *Inspiring Safety*, sets a new benchmark for protection.

Loaded with numerous features, Betagard 5SL is the only patented MCB with a unique **SLR** (Slide Latch-Release)

feature for tool free removal of MCB from DIN rail. It also allows single MCB removal from a bus mounted assembly of MCBs. Betagard 5SL MCB is ergonomically designed and allows user-friendly switching. ON-OFF Status is easily recognizable thanks to the color coded switching position indicator on its attractive grey lever. With highly effective touch protection against accidental contact, Betagard 5SL range is available in current rating upto 63A in B and C characteristics.

### Features and Benefits



BIS approval for ISI marking as per latest IS/IEC 60898:2002 for assured quality and protection



Green product – Recyclable, low watt loss, free from hazardous material like CFC and silicon (ROHS)



MCB with patented unique **SLR** (Slide Latch-Release) feature for tool free removal from DIN rail. It also allows individual MCBs to be removed from bus mounted assembly

# Betagard Miniature Circuit Breakers & DC Circuit Breakers

## Betagard 5SL MCBs



Ergonomically designed, with a user friendly lever for effortless switching



To highlight exact switching position, easily recognizable color coded ON-OFF is embedded on the attractive grey lever



Uniquely designed square terminal to accommodate wire up to 35 Sqmm



Highly effective touch protection against accidental contact

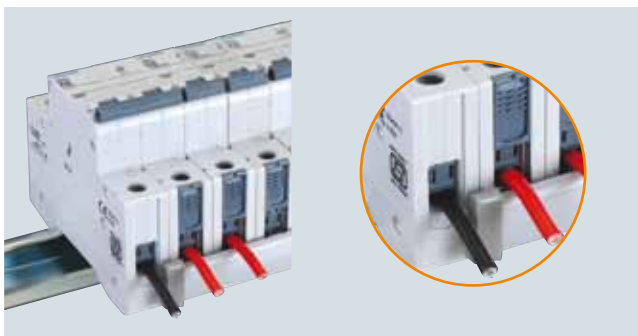

Enables firm mounting of Bus bar together with wire and front access of wires for safer installation



Terminals can accommodate 2 wires of same cross section (Solid up to 2 X 10 mm<sup>2</sup> and finely stranded with end sleeve up to 2 X 4 mm<sup>2</sup>) without twisting wire strands facilitates easier and safe wiring



Side mounting accessories like auxiliary switches and fault signaling contacts available for special applications



Lever locking device with maximum 6 mm shackle

# Betagard Miniature Circuit Breakers & DC Circuit Breakers

## Betagard 5SL MCBs

### Technical Specifications

			Betagard 5SL
<b>Standards</b>			IS/IEC 60898-1 :2002
<b>Tripping characteristic</b>			B, C
<b>Number of poles</b>	1		1P
	2		2P
	3		3P
	4		4P
<b>Rated voltage</b>		V AC	240/415
<b>Operational voltage</b>	min.	V AC/DC	24
	max.	V DC/pole	60 <sup>1)</sup>
	max.	V AC	440
<b>Rated breaking capacity</b>	acc. to IS/IEC 60898-1	kA AC	7.5
<b>Current Rating</b>			B - 6A to 63A C - 0.5A to 63A
<b>Insulation coordination</b>			
• Rated insulation voltage		V AC	250/440
• Degree of Pollution for overvoltage category III			2
<b>Touch Protection</b>	EN 50274		Yes
<b>Line load reversibility</b>			Yes
<b>Degree of protection</b>			IP20
<b>CFC and silicone-free</b>			Yes
<b>Terminals</b>			
• Terminal tightening torque, recommended		Nm	2.5 ... 3
<b>Conductor cross-sections</b>			
• Solid and stranded		mm <sup>2</sup>	0.75....35
• Finely stranded with end sleeve, max.		mm <sup>2</sup>	0.75....25
<b>Mounting position</b>			Any
<b>Average Service life (with rated load)</b>			20.000 operations
<b>Ambient temperature</b>			
		°C	-25 ... +45, occasionally +55, max. 95% humidity, storage temperature: -40 ... +75



<sup>1)</sup> The operational voltage 60 V DC/pole takes into account a battery charging voltage with peak value of 72 V



# Betagard Miniature Circuit Breakers & DC Circuit Breakers

## Betagard 5SL MCBs

### Selection and ordering data



7500	$I_n$ A	Mounting width MW <sup>1)</sup>	Characteristic B Order No.	Characteristic C Order No.	Std. Pkg. (Nos.)
<b>MCBs</b>					
1P, 240/415 V AC					
	0.5	1	--	5SL61057RC	1/12
	1		--	5SL61017RC	1/12
	2		--	5SL61027RC	1/12
	3		--	5SL61037RC	1/12
	4		--	5SL61047RC	1/12
	6		5SL61066RC	5SL61067RC	1/12
	8		--	5SL61087RC	1/12
	10		5SL61106RC	5SL61107RC	1/12
	13		--	5SL61137RC	1/12
	16		5SL61166RC	5SL61167RC	1/12
	20		5SL61206RC	5SL61207RC	1/12
	25		5SL61256RC	5SL61257RC	1/12
	32		5SL61326RC	5SL61327RC	1/12
	40		5SL61406RC	5SL61407RC	1/12
	50		5SL61506RC	5SL61507RC	1/12
	63		5SL61636RC	5SL61637RC	1/12
2P, 240/415 V AC					
	0.5	2	--	5SL62057RC	1/6
	1		--	5SL62017RC	1/6
	2		--	5SL62027RC	1/6
	3		--	5SL62037RC	1/6
	4		--	5SL62047RC	1/6
	6		5SL62066RC	5SL62067RC	1/6
	8		--	5SL62087RC	1/6
	10		5SL62106RC	5SL62107RC	1/6
	13		--	5SL62137RC	1/6
	16		5SL62166RC	5SL62167RC	1/6
	20		5SL62206RC	5SL62207RC	1/6
	25		5SL62256RC	5SL62257RC	1/6
	32		5SL62326RC	5SL62327RC	1/6
	40		5SL62406RC	5SL62407RC	1/6
	50		5SL62506RC	5SL62507RC	1/6
	63		5SL62636RC	5SL62637RC	1/6

<sup>1)</sup> 1 MW (modular width) = 18 mm.

# Betagard Miniature Circuit Breakers & DC Circuit Breakers

## Betagard 5SL MCBs

### Selection and ordering data

7500	$I_n$ A	Mounting width MW <sup>1)</sup>	Characteristic B Order No.	Characteristic C Order No.	Std. Pkg. (Nos.)
	3P, 415 V AC				
	0.5	3	--	5SL63057RC	1/4
	1		--	5SL63017RC	1/4
	2		--	5SL63027RC	1/4
	4		--	5SL63047RC	1/4
	6		5SL63066RC	5SL63067RC	1/4
	10		5SL63106RC	5SL63107RC	1/4
	16		5SL63166RC	5SL63167RC	1/4
	20		5SL63206RC	5SL63207RC	1/4
	25		5SL63256RC	5SL63257RC	1/4
	32		5SL63326RC	5SL63327RC	1/4
	40		5SL63406RC	5SL63407RC	1/4
	50		5SL63506RC	5SL63507RC	1/4
	63		5SL63636RC	5SL63637RC	1/4
		4P, 415 V AC			
0.5		4	--	5SL64057RC	1/3
1			--	5SL64017RC	1/3
2			--	5SL64027RC	1/3
4			--	5SL64047RC	1/3
6			5SL64066RC	5SL64067RC	1/3
10			5SL64106RC	5SL64107RC	1/3
16			5SL64166RC	5SL64167RC	1/3
20			5SL64206RC	5SL64207RC	1/3
25			5SL64256RC	5SL64257RC	1/3
32			5SL64326RC	5SL64327RC	1/3
40			5SL64406RC	5SL64407RC	1/3
50			5SL64506RC	5SL64507RC	1/3
63			5SL64636RC	5SL64637RC	1/3

<sup>1)</sup> 1 MW (modular width) = 18 mm.



## Dimensional drawings

5SL

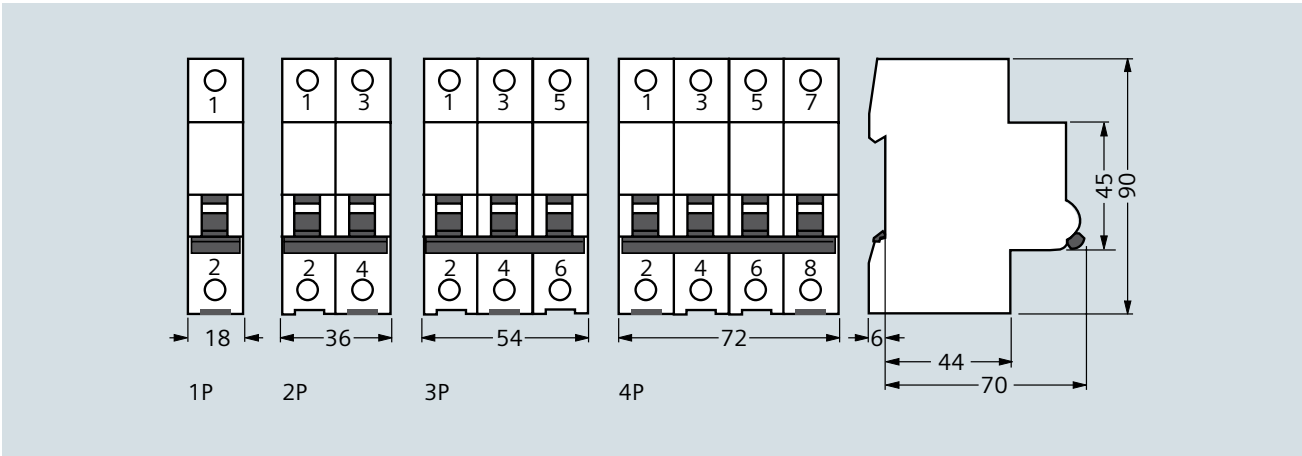

## Schematics

### Symbols

5SL

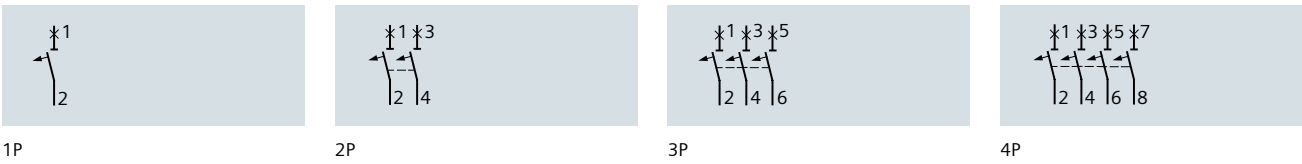

# Betagard Miniature Circuit Breakers & DC Circuit Breakers

## Betagard 5SL MCBs

### Application

#### 'B' Characteristics

'B' Characteristic MCBs react quickly to short circuit, and are set to trip when the current passing through them is between 3 to 5 times the normal full load current. They are suitable for protecting incandescent lighting and socket-outlet circuits in domestic and commercial environments, where there is little risk of surges that could cause the MCB to trip.

#### 'C' Characteristics

'C' characteristics MCBs are used for protection of electrical circuits in general and are most widely used because of its suitability for practically all electrical circuits, cable and line protection. They are capable of protecting the majority of inductive and capacitive loads including most motor and fluorescent lighting loads.

This characteristic allows applying loads having high peak currents without requiring the MCB to be oversized. In fact, thanks to this characteristic, it is possible to apply loads with peak currents up to 5 times  $I_n$ , (rated current) and can

hence be used to best advantage for handling higher inrush currents e.g. lamps, motors, etc. Under 'C' characteristics, the magnetic operating limits (for short-circuit operations) are between 5 and 10 times the rated current ( $I_n$ ) of MCB. For example the instantaneous mechanism of a 10A MCB will operate between 50A and 100A in an overcurrent situation. The thermal operating limits (for overload operation) are between 1.13 and 1.45 of the rated current ( $I_n$ ) of the MCB.

#### DC Operation

Single pole MCBs can be used up to 60V DC and double pole up to 110V DC.

However, they should not be used below 18V DC. Though the thermal operation is delayed but this is negligible. The instantaneous tripping characteristic must be increased by 40% (e.g. a Type 'C' MCB has a magnetic tripping characteristic between 5 and 10 times the rated current). This magnetic tripping characteristic would therefore become between 7 and 14 times the rated current.

### Characteristic curves

#### Tripping Characteristics as per IS/IEC 60898-1:2002

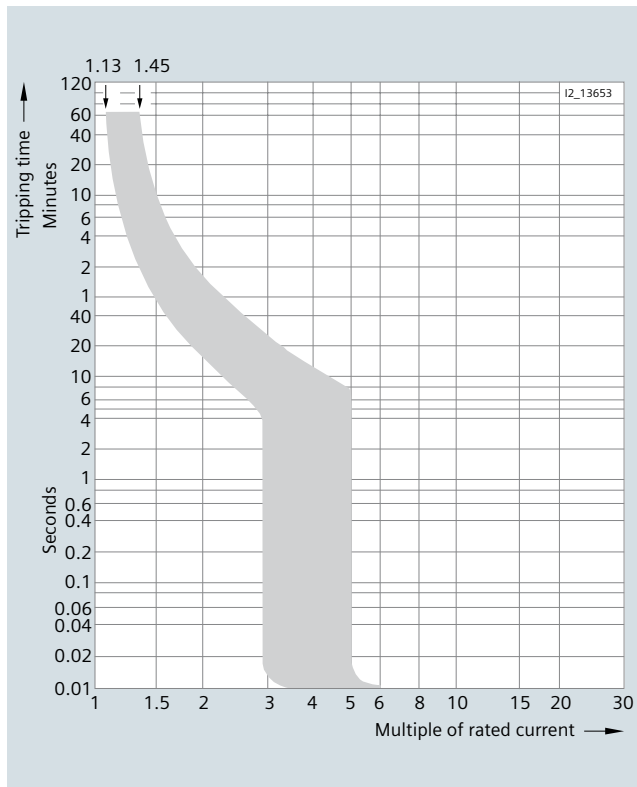

#### Tripping characteristic B

MCBs with this tripping characteristic are designed for universal use in socket outlet and lighting circuits.

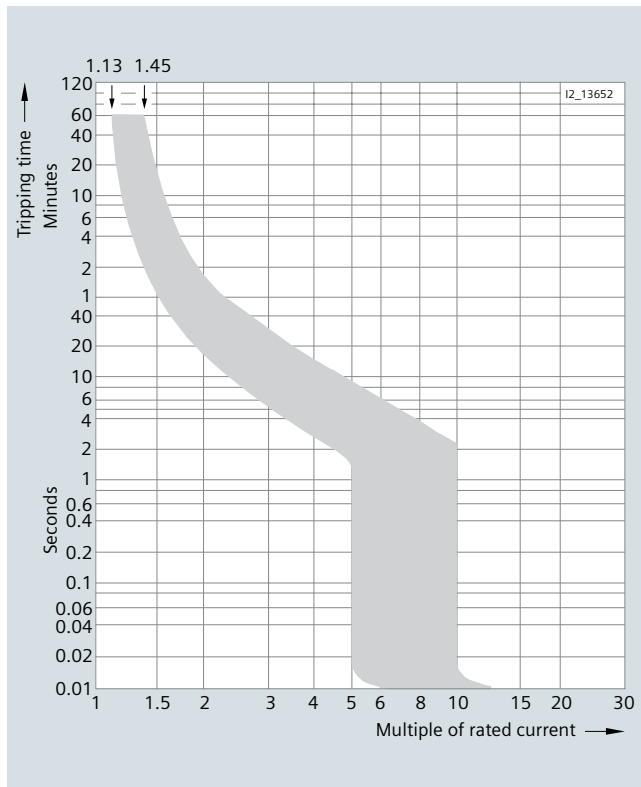

#### Tripping characteristic C

In lamp and motor circuits with higher starting currents, MCBs with tripping characteristic C are generally used.

# Betagard Miniature Circuit Breakers & DC Circuit Breakers

Betagard 5SL MCBs

## Tripping characteristics

### Tripping characteristics at an ambient temperature of 30°C

Tripping characteristic	Standards	Thermal trips Test currents:			Electromagnetic trips Test currents:		
		Limiting test current $I_1$	Minimum test current $I_2$	Tripping time $I_n \leq 63$ A $t$	Hold $I_4$	Latest tripping instant $I_5$	Tripping time $t$
B	IS/IEC 60898-1,	$1.13 \times I_n$	$1.45 \times I_n$	> 1 h < 1 h	$3 \times I_n$	$5 \times I_n$	$\geq 0.1$ s < 0.1 s
C	IS/IEC 60898-1,	$1.13 \times I_n$	$1.45 \times I_n$	> 1 h < 1 h	$5 \times I_n$	$10 \times I_n$	$\geq 0.1$ s < 0.1 s

### Internal power loss $P_v$ of the miniature circuit breaker 5SL6

(Data per pole with  $I_n$ )

$I_n$	Requirement of IS/IEC 60898		Characteristic B	Characteristic C
	$P_v$	W	$P_v$	W
5SL6				
0,5	3		--	0.9
1	3		--	1.2
2	3		--	1.2
3	3		--	1.2
4	3		--	1.3
6	3		1.15	0.6
8	3		--	0.7
10	3		1.5	1.2
13	3.5		--	1.8
16	3.5		1.9	1.7
20	4.5		2.2	1.7
25	4.5		2.3	2.2
32	6		2.4	2.5
40	9		3.4	3.3
50	9		3.8	3.5
63	13		5.4	4.4

# Betagard Miniature Circuit Breakers & DC Circuit Breakers

## Betagard 5SX4 MCBs

### Overview

#### General

Betagard 5SX4 range of MCBs have rated breaking capacity of 10kA. They comply to the latest national and international standards, with current ratings from 0.5A to 63A.

For applications in industry and in system and plant engineering, add-on accessories are available, such as auxiliary contacts (AC), fault-signal contacts (FC) and shunt trips (ST).

#### Short circuit operation

At high values of overcurrent (i.e. short circuit current) a plunger in the solenoid is moved with sufficient force to physically separate the contacts. The greater the short circuit current, the greater the force with which the plunger is moved and faster the circuit is disconnected. A secondary action will ensure that the circuit breaker mechanism is tripped and prevents the contacts from reclosing. It is the rapid speed with which the contacts are forced apart coupled with other features of MCBs, which provides the Current limiting capability and safe interruption up to 10,000A.

The rapid speed at which the contacts are parted prevents the fault current from reaching its prospective value. The arc drawn between the contacts is moved by magnetic forces into the multiple plate arc chamber where the arc is split, rapidly cooled and extinguished. The total operating time of the MCB is between 3 to 5 milliseconds. The energy let through ( $I^2t$ ) of the device is kept to a minimum thus offering a very high degree of protection.

#### Current limiting class 3

5SX4 type MCBs significantly limit the let-through current (when a fault occurs) due to the ultra – fast contact separation and the quick quenching of the emergency arc in the chamber. Thus, generally, they fall below the permissible limiting  $I^2t$  values of the energy limiting class 3, specified in DIN VDE 0641 Part II by 50%. This guarantees excellent discrimination with the upstream protective devices and reduces the thermal stress on the downstream connected equipments.

Chart indicates the let through energy values of 10kA,

16A MCB according to EN 60898.

This MCB (16Amps) will allow only 50% of 84,000 (A<sup>2</sup>S) let-through energy thereby reducing thermal stress to bare minimum value on the downstream equipment.

As these MCBs meet the requirements of current limiting class 3, according

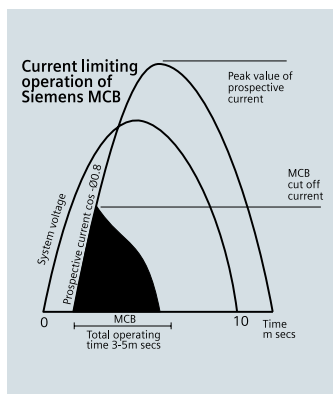

to EN 60898 without difficulty, they are therefore marked with symbol 

10000
3

#### Standards

According to IS/IEC 60898-1.

#### Features at a glance

- Current limiting class 3 type breakers.
- "C" / "D" tripping characteristics.
- Service life: Average 20,000 operations at rated load.
- Suitable for AC and DC circuits.
- Wide range of Add on accessories.
- Trip Free mechanism.
- Finger Touch Proof Terminals, provide installation safety.
- Totally safe and dependable - computer calibrated testing.
- Recessed ON – OFF lever ensuring no accidental operation.
- Combined terminals allow busbar and feeder cable to be simultaneously connected.
- ON-OFF Lever sealable in ON and OFF position.
- Can be mounted in any position.

Rated Current	Current Limiting Class according to EN 60898		
	1	2	3
16 A	Permissible let-through $I^2t$ (A <sup>2</sup> S)		
	No limit	2,90,000	84,000

### 'C' Characteristics

'C' characteristics MCBs are used for protection of electrical circuits in general and are most widely used because of its suitability for practically all electrical circuits, cable and line protection. They are capable of supplying the majority of inductive and capacitive loads including most motor and fluorescent lighting loads.

This characteristic allows applying loads having high peak currents without requiring the MCB to be oversized. In fact, thanks to this characteristic, it is possible to apply loads

with peak currents up to 5 times  $I_n$ , (rated current) and can hence be used to best advantage for handling higher inrush currents e.g. lamps, motors, etc. Under 'C' characteristics, the magnetic operating limits (for short-circuit operations) are between 5 and 10 times the rated current ( $I_n$ ) of MCB. For example the instantaneous mechanism of a 10A MCB will operate between 50A and 100A in an overcurrent situation. The thermal operating limits (for overload operation) are between 1.13 and 1.45 of the rated current ( $I_n$ ) of the MCB.

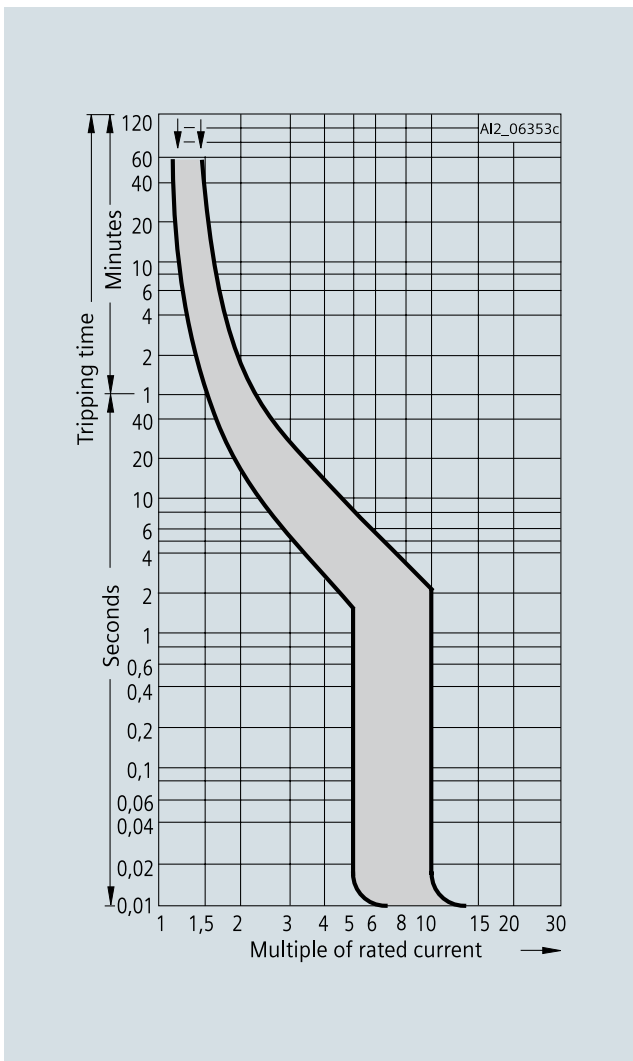

Tripping Characteristics: C

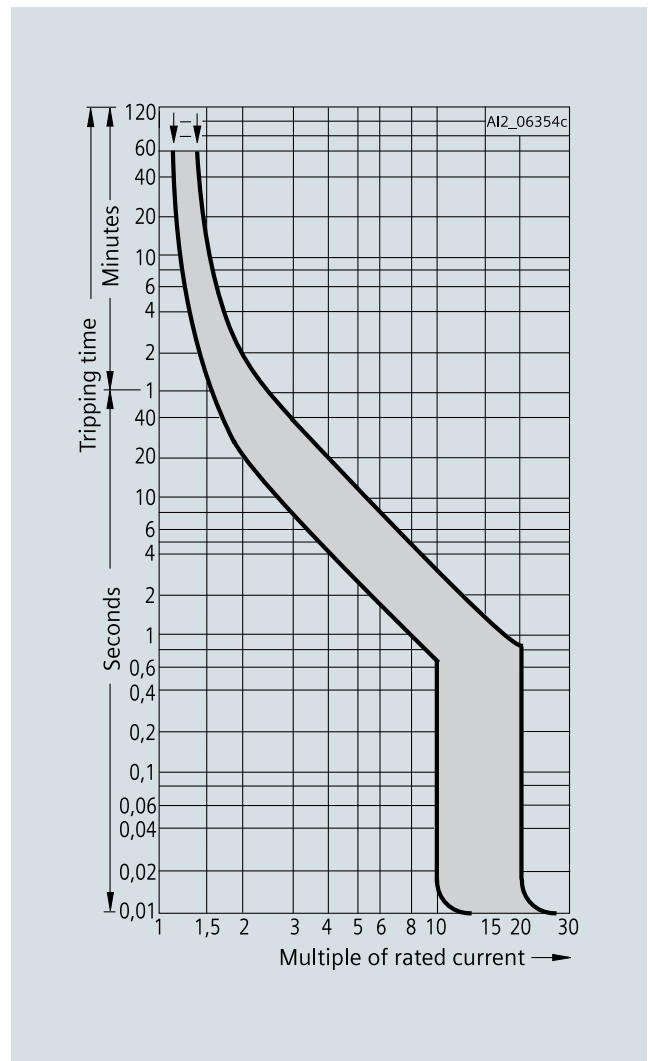

Tripping Characteristics: D

# Betagard Miniature Circuit Breakers & DC Circuit Breakers

## Betagard 5SX4 MCBs

### Effect of Higher Operating Voltages

Betagard MCB is designed to operate at 240/415V, 50Hz. However the device can operate at 480V, 50Hz with a reduction in breaking capacity of 50%.

### DC Operation

Single pole MCBs can be used up to 60V DC and double pole up to 110V DC.

However, they should not be used below 18V DC. Though the thermal operation is delayed but this is negligible. The instantaneous tripping characteristic must be increased by 40% (e.g. a Type 'C' MCB has a magnetic tripping characteristic between 5 and 10 times the rated current. This magnetic tripping characteristic would therefore become between 7 and 14 times the rated current.

### Frequency Variation

MCBs may be used up to their normal voltage rating on 400Hz supplies; however the magnetic tripping characteristic must be increased by 30% (e.g. Type 'C' MCB with magnetic characteristics between 5 and 10 times the rated current would become between 6.5 and 13 times rated current.

### Effect of temperature on tripping characteristics:

Betagard MCBs are designed to meet the requirements of IS 8828 / IEC 60898 for tripping performance at ambient temperature 30°C. At other operating temperature the overload tripping band is modified by approximately 5% per 10° kelvin temperature difference, which increases for lower and decreases for higher temperatures than 30°C.

### "D" Characteristics

**D characteristics MCBs** are used for protection of electrical circuits involving significant inrush currents like solenoid valves, capacitor banks, transformers, etc.

The main use of D characteristics MCBs is to ensure correct sizing of the device wherein high inrush currents are prevailing.

This characteristics allows to use in a high inrush current circuits without requiring the MCB to be oversized.

**D characteristics MCB** shall take the inrush current with peak up to 10 times  $I_n$ , (Rated current) and can be used best advantage for handling much higher inrush currents eg: Switching solenoids/capacitor banks/transformers etc.

**Under D characteristics**, the magnetic operating limits (for short circuit operations) are between 10 to 20 times the rated current of MCB.

For example the instantaneous mechanism of 10A MCB will operate between 100A and 200A in an over current situation.

### Selectivity of miniature circuit-breakers/fuses

Generally, distribution networks are configured as radial networks. An overcurrent device must be provided at each reduction of the conductor cross section. This results in a cascade graded according to the rated current, which should, where possible, provide selectivity.

Selectivity means, that in the event of a fault, only the protective device in the vicinity of the fault trips. Thus, parallel current paths can continue to provide the necessary power.

For MCBs with upstream fuses, the selectivity limit essentially depends on the current limits and tripping characteristics of the MCB as well as on the pre-arcing  $I^2t$  value of the fuse. Therefore, MCBs with different characteristics and rated breaking capacities also have different selectivity limits. The subsequent tables show the currents up to which selectivity is provided between MCBs and upstream fuses according to DIN VDE 0636 Part 21. The values specified in kA are limit values which have been determined under unfavourable test conditions. In practice, better values can be obtained, depending on the type of the upstream fuse.

In the event of a short circuit, when using the 5SX4, MCBs and fuses according to DIN VDE 0636 Part 21, Selectivity is provided up to the indicated values in kA.



### Technical data

<b>Standards</b>	IS/IEC 60898 - 1: 2002		
<b>Series</b>	5SX4 / 5SJ4		
<b>Tripping characteristics</b>	'C' / 'D'		
<b>No. of poles</b>	1P, 2P, 3P, 4P		
<b>Rated voltage</b>	Volts	240 / 415 V AC, 50/60 Hz	
		SP – 60V DC, DP – 110V DC	
<b>Current Range</b>	Amps	0.5 – 63	
<b>Operational voltage</b>	min. AC/DC V	24	
	max. DC V/Pole	60	
	max. AC V	440	
<b>Rated Breaking Capacity</b>			
acc. to IS 8828 / IEC 60898, DIN VDE 0641	AC	kA	10
<b>Insulation coordination</b>			
Rated insulation voltage	250/440 V AC		
Degree of pollution for overvoltage category III	2		
<b>Mounting</b>	on a 35 mm mounting rail (EN 50 022)		
<b>Conductor cross sections</b>			
Solid and stranded, max.			
Upper terminal	mm <sup>2</sup>	16	
Lower terminal	mm <sup>2</sup>	25	
Finely stranded with end sleeves, max.			
Upper terminal	mm <sup>2</sup>	16	
Lower terminal	mm <sup>2</sup>	25	
<b>Terminal tightening torque</b>			
(power driver setting)	Nm	2.5 - 3	
<b>Supply connection</b>	As required, top or bottom.		
<b>Mounting position</b>	As required in any position.		
<b>Endurance</b>	On an average 20,000 operations at rated load		
<b>Ambient temperature</b>	°C	-25 to +45, occasionally +55 max. 95% humidity, Storage temperature: -40 to +75	
<b>Resistance to climate</b>	According to IEC 68-2-30, 6 cycles		
<b>Resistance to vibration</b>	m/s <sup>2</sup>	60 at 10 to 150 Hz according to IEC 68-2-6	

# Betagard Miniature Circuit Breakers & DC Circuit Breakers

Betagard 5SX, 5SJ MCB

## Selection and ordering data

### Betagard Miniature Circuit Breakers - 5SX4/5SJ4, 10kA with C and D characteristics

Un: 240/415V, 50...60Hz can be used in systems upto 60Vdc, 1P and 110Vdc, 2P

Standards: IS/IEC 60898 - 1: 2002





Breaking capacity: 10kA as per IS 60898 part I: 2002

With ISI marking: CM/L No. 2255548

IS/IEC 60898 - 1



CM/L No. 2255548

10000 3		Rated current $I_n$ (A)	MW#	Reference No. Characteristic C	Reference No. Characteristic D	Std. Pkg. (Nos.)
	1-pole	0.5	1	5SX41057RC	5SX41058RC	1/20
		1		5SX41017RC	5SX41018RC	1/20
		2		5SX41027RC	5SX41028RC	1/20
		4		5SX41047RC	5SX41048RC	1/20
		6		■ 5SX41067RC	■ 5SX41068RC	1/20
		10		■ 5SX41107RC	■ 5SX41108RC	1/20
		16		■ 5SX41167RC	■ 5SX41168RC	1/20
		20		■ 5SX41207RC	5SX41208RC	1/20
		25		■ 5SX41257RC	5SX41258RC	1/20
		32		■ 5SX41327RC	5SX41328RC	1/20
		40		5SX41407RC	5SJ41408RC	1/20
		50		5SX41507RC	5SJ41508RC	1/20
		63		5SX41637RC	5SJ41638RC	1/20
	2-pole	0.5	2	5SX42057RC	5SX42058RC	1/10
		1		5SX42017RC	5SX42018RC	1/10
		2		5SX42027RC	5SX42028RC	1/10
		4		5SX42047RC	5SX42048RC	1/10
		6		5SX42067RC	5SX42068RC	1/10
		10		5SX42107RC	5SX42108RC	1/10
		16		5SX42167RC	5SX42168RC	1/10
		20		5SX42207RC	5SX42208RC	1/10
		25		5SX42257RC	5SX42258RC	1/10
		32		■ 5SX42327RC	■ 5SX42328RC	1/10
		40		5SX42407RC	5SJ42408RC	1/10
		50		5SX42507RC	5SJ42508RC	1/10
		63		■ 5SX42637RC	■ 5SJ42638RC	1/10
	3-pole	0.5	3	5SX43057RC	5SX43058RC	1/10
		1		5SX43017RC	5SX43018RC	1/10
		2		5SX43027RC	5SX43028RC	1/10
		4		5SX43047RC	5SX43048RC	1/10
		6		5SX43067RC	5SX43068RC	1/10
		10		5SX43107RC	5SX43108RC	1/10
		16		5SX43167RC	5SX43168RC	1/10
		20		5SX43207RC	5SX43208RC	1/10
		25		5SX43257RC	5SX43258RC	1/10
		32		■ 5SX43327RC	■ 5SX43328RC	1/10
		40		■ 5SX43407RC	■ 5SJ43408RC	1/10
		50		5SX43507RC	5SJ43508RC	1/10
		63		■ 5SX43637RC	■ 5SJ43638RC	1/10
	4 pole	0.5	4	5SX44057RC	5SX44058RC	1/10
		1		5SX44017RC	5SX44018RC	1/10
		2		5SX44027RC	5SX44028RC	1/10
		4		5SX44047RC	5SX44048RC	1/10
		6		5SX44067RC	5SX44068RC	1/10
		10		5SX44107RC	5SX44108RC	1/10
		16		5SX44167RC	5SX44168RC	1/10
		20		5SX44207RC	5SX44208RC	1/10
		25		5SX44257RC	5SX44258RC	1/10
		32		■ 5SX44327RC	■ 5SX44328RC	1/10
		40		■ 5SX44407RC	■ 5SJ44408RC	1/10
		50		5SX44507RC	5SJ44508RC	1/10
		63		5SX44637RC	■ 5SJ44638RC	1/10

Note:

■ Stock Items

# 1MW (Module Width) = 18mm



### Dimensions

#### Betagard MCBs 5SX4

1P

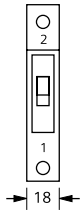

MW = 1

2P

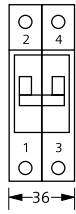

MW = 2

3P

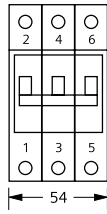

MW = 3

4P

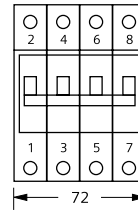

MW = 4

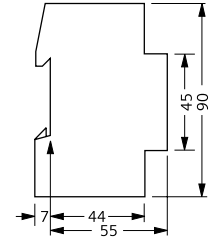

1MW = 18mm

#### Betagard MCBs 5SJ4

1P

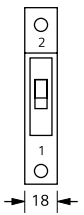

MW = 1

2P

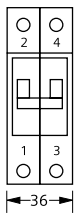

MW = 2

3P

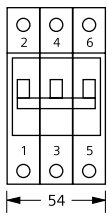

MW = 3

4P

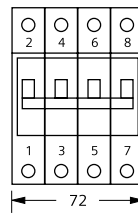

MW = 4

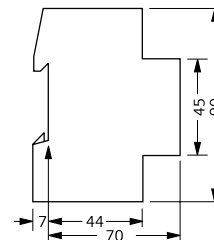

1MW = 18mm

### Wide range of Modular Devices for various applications \*

			
<b>Insta Contactors</b>	<b>Changeover switches</b>	<b>Analog &amp; Digital time switches</b>	
			
<b>Voltage Relays</b>	<b>Digital Voltmeter &amp; Ammeter</b>	<b>Phase indicators</b>	<b>Surge Protection Devices</b>

\* For more details, kindly contact our sales office.

# Betagard Miniature Circuit Breakers & DC Circuit Breakers

## Betagard DC Circuit Breakers 5SX5, 5SJ5

### Overview

In alternating current circuits, arc quenching is assisted by the fact that current passes through zero, and that the current can only continue to flow if the arc is re-stuck across the open contacts during the following half wave. Direct current does not provide such assistance. In this case, a high arc voltage must be developed in order to stop the flow of the DC current.

Therefore, the DC switching capacity depends on the arc quenching method employed by the switching device, on the network voltage & on the inductive reactance of the circuit.

In order to address DC network protection, Siemens offers 5SX5/5SJ5 series DC circuit breakers from 0.5A to 63A in Single pole & Double pole version.

When using DC CBs in DC networks, care must be taken to ensure the contact polarity of the connections.

In trains fed by a DC voltages (metros & railways) there is a wide range of L/R (Time Constants) values and over current levels. Consequently such special application requires fully enclosed operations.

For such application 5SX5/5SJ5 is the right choice for load up to 63 Amps to ensure people safety

### Features

- Compact in size and hence reduction in panel size.
- Total recessed dial avoids accidental switching due to human negligence.
- Suitable for breaking capacity up to 10 kA
- Accessories like Aux block, fault signal contacts can be retro fitted at site.
- Finger touch proof (FTPT) ensures total safety for operator.

### CBs for DC and AC/DC Applications

In DC networks up to 110 V, existing 5SX4 MCBs are suitable for single-pole and double-pole application.

For higher voltages, the versions 5SX5/5SJ5 are required. Contrary to the other product range, the arcing chamber area of 5SX5/5SJ5 is equipped with an additional permanent magnet to support the positive quenching of the arc.

For this reason, the polarity of the DC circuit breaker is clearly marked and must be observed when connecting the cables and conductors.

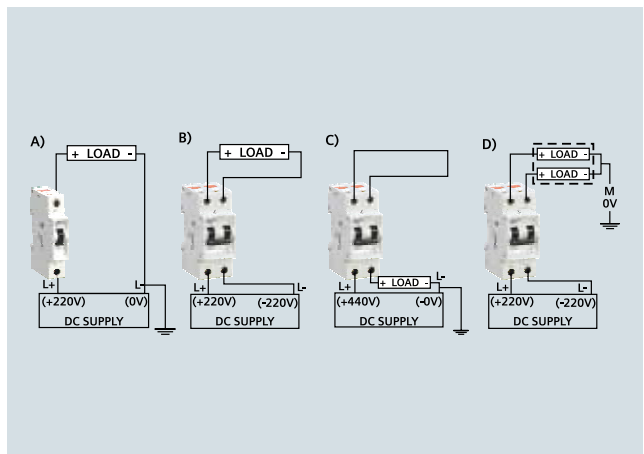

### Technical data

#### Technical Data – 5SX5, 5SJ5 DCCBs

<b>Series</b>	5SX5, 5SJ5		
<b>Current Range</b>	0.5 ... 63 A		
<b>Rated voltage</b>	220 V DC, 1P and 440 V DC, 2P		
<b>Poles</b>	1P, 2P		
<b>Rated breaking capacity</b>	10 kA (as per IS 60947 / IEC 60947)		
<b>Terminal lighting torque</b>	2 to 2.5 Nm		
<b>Supply connection</b>	Polarity to be observed (Refer connection diagram)		
<b>Ambient temperature</b>	-25°C to +45°C occasionally +55°C, max. 95% humidity, storage temp. -40°C to +75°C		
<b>Conductor cross sections</b>			
Solid and stranded, max.			
Upper terminal	mm <sup>2</sup>		16
Lower terminal	mm <sup>2</sup>		25
Finely stranded with end sleeves, max.			
Upper terminal	mm <sup>2</sup>		16
Lower terminal	mm <sup>2</sup>		25



# Betagard Miniature Circuit Breakers & DC Circuit Breakers

## Betagard DC Circuit Breakers 5SX5, 5SJ5



### Selection and ordering data

#### Betagard DC Circuit Breakers - 5SX5/5SJ5, 10kA DC Circuit Breakers

Un: 220Vdc/1P & 440Vdc/2P

Standards: IS 13947-2, IEC 60947-2

Breaking capacity: 10kA as per IS 13947-2

		Rated current $I_n$ (A)	MW#	Reference No.	Std. Pkg. (Nos.)
	1-pole	0.5	1	5SX51057RC	1/20
		1		5SX51017RC	1/20
		2		5SX51027RC	1/20
		4		5SX51047RC	1/20
		6		5SX51067RC	1/20
		10		5SX51107RC	1/20
		16		5SX51167RC	1/20
		20		5SX51207RC	1/20
		25		5SX51257RC	1/20
		32		5SX51327RC	1/20
		40		5SJ51407RC	1/20
		50		5SJ51507RC	1/20
		63		5SJ51637RC	1/20
				2-pole	0.5
1	5SX52017RC		1/10		
2	5SX52027RC		1/10		
4	5SX52047RC		1/10		
6	5SX52067RC		1/10		
10	5SX52107RC		1/10		
16	5SX52167RC		1/10		
20	5SX52207RC		1/10		
25	5SX52257RC		1/10		
32	5SX52327RC		1/10		
40	5SJ52407RC		1/10		
50	5SJ52507RC		1/10		
63	5SJ52637RC		1/10		

Note:

# 1MW (Module Width) = 18mm



### Dimensions

#### Betagard DC circuit breakers 5SX5

1P

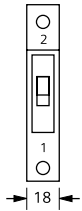

MW = 1

1MW = 18mm

2P

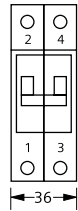

MW = 2

3P

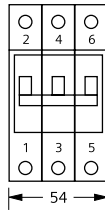

MW = 3

4P

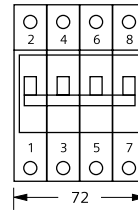

MW = 4

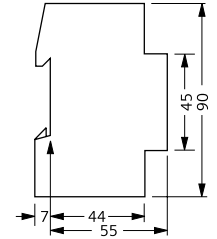

#### Betagard DC circuit breakers 5SJ5

1P

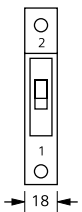

MW = 1

1MW = 18mm

2P

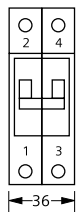

MW = 2

3P

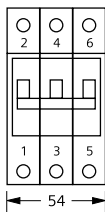

MW = 3

4P

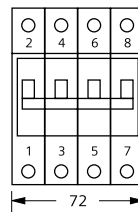

MW = 4

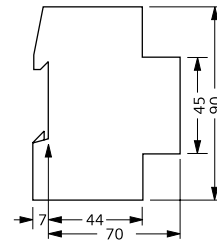

# Betagard Miniature Circuit Breakers & DC Circuit Breakers

## Betagard Miniature Circuit Breakers Type 5SP4

### Overview

#### General

Siemens Betagard range of MCBs type 5SP4 offer high short circuit breaking capacity equal to 10kA as per IS/IEC 60898 - 1: 2002. These MCBs have excellent current limiting and selectivity characteristics. MCBs are available with C as well D tripping characteristics with current range of 80A-125A and 80A-100A respectively.

#### Features at a glance

- Current limiting class 3 MCBs
- Finger touch proof terminals (FTPT)
- Trip free mechanism
- Suitable for AC/DC circuits
- DIN rail and screw mounting possible
- Accessories like auxiliary contact, shunt trip, undervoltage release, fault signal contact

#### Applications

- Mainly as an incomer MCB in residential, industrial and commercial applications
- C characteristics MCBs suitable for general line protection especially with higher starting current lamps, motors etc.
- D characteristics MCBs suitable for high inrush current applications line transformers generating significant pulses, solenoid valves etc.

### Technical data

Standards	IS/IEC 60898 - 1: 2002	
Series	5SP4	
Tripping characteristics	C	D
Current range	80A, 100A and 125A	80A and 100A
Rated voltage	240/415VAC and 60V DC/pole	
Operational voltage (max)	250/440VAC and 60V DC/pole	
Poles	SP, DP, TP, FP	
Rated breaking capacity	AC 10kA (as per IS 8828 / IEC 60898)	
	AC 10kA* (as per IS 13947 / IEC 60947)	
Depth	70mm	
Terminal tightening torque	3 to 3.5Nm	
Conductor cross sections	Solid and stranded	
	Fine stranded with end sleeves	
	0.75 – 50mm <sup>2</sup>	0.75 – 35mm <sup>2</sup>
Supply connection	As required, top or bottom Polarity to be observed for DC applications	
Ambient temperature	-25°C to +45°C occasionally +55°C, max. 95% humidity, storage temp. -40°C to +75°C	
Service life	Average 20,000 operation at rated load	

# Betagard Miniature Circuit Breakers & DC Circuit Breakers

Betagard Miniature Circuit Breakers  
Type 5SP4

## Selection and ordering data

Betagard Miniature Circuit Breakers, LS125 5SP4, 10kA MCBs with C/D characteristics

IS/IEC 60898 - 1

Un: 240/415V, 50...60Hz can be used in systems upto 60Vdc,1P and 110Vdc,2P

Standards: IS/IEC 60898 - 1: 2002

Breaking capacity: 10kA as per IS 60898;

With ISI marking: CM/L No. 2255548



CM/L No. 2255548

## C characteristic

		Rated Current $I_n$ (A)	MW <sup>#</sup>	Reference No	Std. Pkg. (Nos.)
	1-pole	80	1.5	5SP41807RC	1/10
		100		5SP41917RC	1/10
		125		5SP41927RC	1/10
	2-pole	80	3	■ 5SP42807RC	1/5
		100		■ 5SP42917RC	1/5
		125		■ 5SP42927RC	1/5
	3-pole	80	4.5	■ 5SP43807RC	1
		100		■ 5SP43917RC	1
		125		■ 5SP43927RC	1
	4-pole	80	6	■ 5SP44807RC	1
		100		■ 5SP44917RC	1
		125		■ 5SP44927RC	1

## D characteristic

	1-pole	80	1.5	5SP41808RC	1/10
		100		5SP41918RC	1/10
	2-pole	80	3	5SP42808RC	1/5
		100		5SP42918RC	1/5
	3-pole	80	4.5	5SP43808RC	1
		100		5SP43918RC	1
	4-pole	80	6	5SP44808RC	1
		100		5SP44918RC	1

## Dimensions

### Betagard MCBs 5SP4

1P

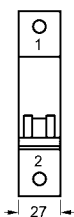

MW = 1

2P

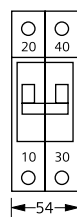

MW = 2

3P

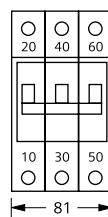

MW = 3

4P

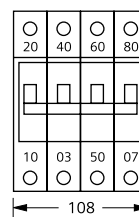

MW = 4

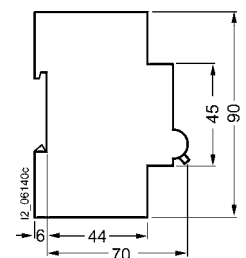

1MW = 18mm

# Betagard Miniature Circuit Breakers & DC Circuit Breakers

## Betagard Isolator

### Design, Construction & Features

#### Isolators - 5TE:

Switch disconnectors for manual operation, as a control switch is available for switching loads in two, three and four pole versions; current ratings are from 25A to 80A.

### Product Overview & Accessories

#### Betagard Isolators - 5TE3

Un: 240/415V, 50...60Hz

Standards:IS13947-3/IEC60947-3



	Rated current $I_n$ (A)	MW#	Reference No.	Std. Pkg. (Nos.)
2-pole	25	2	5TE39037Y	1/10
	40		5TE39047Y	1/10
	63		5TE39137Y	1/10
	80		5TE39157Y	1/10
3-pole	25	3	5TE39057Y	1/10
	40		5TE39067Y	1/10
	63		5TE39077Y	1/10
	80		5TE39167Y	1/10
4-pole	25	4	5TE39087Y	1/10
	40		5TE39107Y	1/10
	63		5TE39117Y	1/10
	80		5TE39177Y	1/10

Note:

# 1MW (Module Width) = 18mm



## Accessories

Betagard 5SL , 5SP, 5SJ miniature circuit breakers are suitable for mounting auxiliary switches and fault signal contacts. Lever locking device is also available for Betagard 5SL.

### Auxiliary switches (AS)

The auxiliary switch (AS) always signals the contact position of the miniature circuit breaker, regardless of whether the miniature circuit breaker is tripped manually or as a result of a fault.

### Fault signal contacts (FC)

The fault signal contact (FC) signals the tripping of the miniature circuit breaker in the event of a fault, such as an overload or a short circuit. The contact position does not change if miniature circuit breaker is tripped manually.

### Lever locking device

MCB lever locking device is available for Betagard 5SL MCBs. MCB lever can be locked in ON or OFF position. Any lock of maximum 6 mm shackle can be used with this device.

## Benefits



The Betagard miniature circuit breakers are ideal for the quick and easy mounting of auxiliary switches and fault signal contacts. Captive metal brackets ensure the quick and easy mounting of devices on the miniature circuit breakers without tools.

## Technical specifications

		Auxiliary switches (AS) 5ST3 010	Fault signal contacts (FC) 5ST3 020
<b>Standards</b>		EN 62019; IEC/EN 60947-5-1; UL 1077; CSA C22.2 No. 235	
<b>Short-circuit protection</b>		Miniature circuit breaker or gG 6 A fuse	
<b>Contact load</b>			
• Min.		50 mA, 24 V	50 mA, 24 V
• Max.		--	--
• 400 V AC, AC-14, NO	A	2	2
• 230 V AC, AC-14, NO	A	6	6
• 400 V AC, AC-13, NC	A	2	2
• 230 V AC, AC-13, NC	A	6	6
• 220 V DC, DC-13, NO+NC	A	1	1
• 110 V DC, DC-13, NO+NC	A	1	1
• 60 V DC, DC-13, NO+NC	A	3	3
• 24 V DC, DC-13, NO+NC	A	6	6
<b>Service life, on average, with rated load</b>		20000 actuations	20000 actuations
<b>Conductor cross-sections</b>	mm <sup>2</sup> AWG	0.5 ... 2.5 22 ... 14	0.5 ... 2.5 22 ... 14
<b>Terminals</b>			
• Terminal tightening torque	Nm lb/in	0.5 4.5	0.5 4.5





## Accessories for Betagard MCBs/Isolators

Item Description	Reference No.	Std. Pkg. (Nos.)
Vertical Spacer	5ST2120	10

# Betagard Miniature Circuit Breakers & DC Circuit Breakers

## Betagard 5SL MCBs

### Selection and ordering data

	Mounting width MW <sup>1)</sup>	Reference No.
 <p><b>Auxiliary switches (AS)</b></p> <p>1 NO + 1 NC</p> 	0.5	5ST3010
 <p><b>Fault signal contacts (FC)</b></p> <p>1 NO + 1 NC</p> 	0.5	5ST3020
 <p>For 5SL miniature circuit breakers For padlock with 3 ... 6 mm shackle</p>		5ST3806

### More information

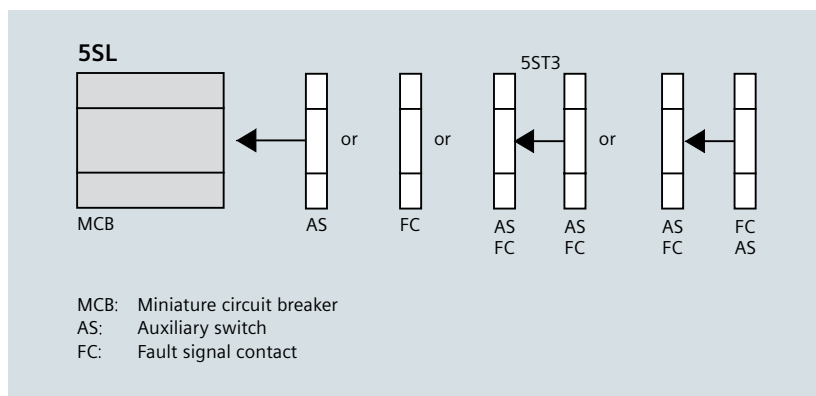

5ST3 010  
5ST3 020

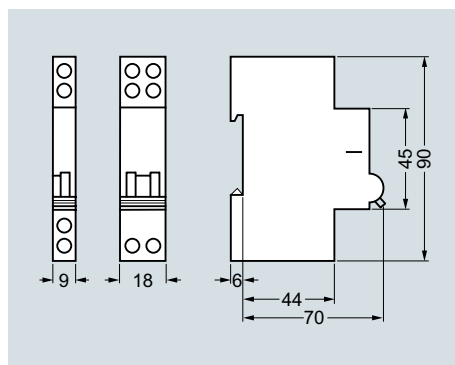

<sup>1)</sup> 1 MW (modular width) = 18 mm.

## Remote controlled mechanism (RC)

### Function / Applications:

- ON/OFF remote control switch of MCB
- Remote switching ON is possible following acknowledgment of fault occurrence
- Manual switching on-site possible
- Remote display of switching status of remote controlled mechanism and MCB



Rated voltage $U_n$	MW#	Type ref. no.
230V AC	3.5	5ST3 050

## Mounting concept (possible configurations)

### Mounting concept

Using this mounting concept, all additional 5ST3 components can be combined with miniature circuit-breaker of 5SP4 & 5SJ series:

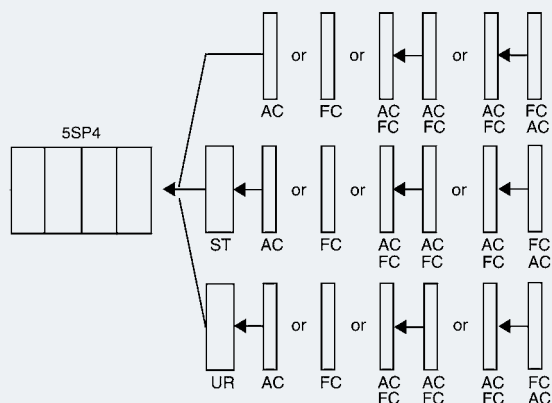

# Betagard Miniature Circuit Breakers & DC Circuit Breakers

## Accessories

### Additional components

#### Shunt trip/undervoltage release for 5SJ and 5SP4

##### Benefits

##### Shunt release

- Can be retrofitted individually
- Suitable for voltages: 110 to 415 V AC, 110 V AC  
24 to 48 V AC/DC
- Can be connected to *instabus* KNX EIB and AS-Interface bus through binary outputs

##### Undervoltage releases

- Can be retrofitted individually (for mounting concept, refer to page 2/7)
- Suitable for voltages: 230 V AC  
110 V DC  
24 V DC

##### Application



##### Shunt release

- Remote tripping of the miniature circuit-breaker

##### Undervoltage releases

- Applicable as remote trip in an EMERGENCY-OFF loop
- Ensures disconnection of the control circuit acc. to EN60204
- In cases of interrupted or insufficient voltage, the undervoltage release trips the miniature circuit-breaker or prevents it from switching on.

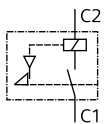
### Selection and ordering data

		Rated voltage $U_n$	MW	Order No.	PS*/ P unit Items
	<b>Shunt trips (ST)</b> 	110 ... 415 V AC	1	5ST3 030	1/5
		24 ... 48 V AC/DC	1	5ST3 031	1/5
	<b>Undervoltage releases (UR)</b> 	230 V AC	1	5ST3 043	1/5
		24 V DC		5ST3 045	1/5

### Rotary Handle Assembly for MCB s (ROH)

##### Benefits

- 5SJ, 5SL, 5SP and 5TE8 series of MCBs/ Isolators can be fitted with Betagard Rotary Handle Assembly (ROH) for installation in Switchgear Cubicles and Distribution Panels
- The ROH gives operating uniformity and improves the aesthetics of the panel.

- The ROH can be padlocked in OFF position with the help of suitable padlocks thereby ensuring complete safety to operating personal during maintenance.
- Door interlock and defeat facility is available as a standard feature.

##### Applications

- Panel Boards / Switch Boards

### Technical Details:

		Product	Order No	Weight 1 item Kg	PS*/ P unit Items
		Rotary Handle Assembly for MCB	5ST38140RC	0.584	1

### Benefits

#### Additional components

- Can be retrofitted individually

#### Auxiliary switches (AS) and fault signal contacts (FC)





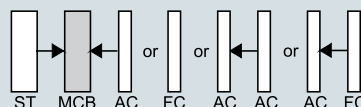

- Mounting with factory-fitted clips
- Max. contact load:  
6 A, 230 V AC, AC-15  
1 A, 220 V DC, DC-13  
according to DIN VDE 0660-200, EN 60947-5-1
- Short-circuit protection through miniature circuitbreakers with  $I_n = 6$  A or gL 6 A fuse, depending on the version.
- Remote display of the miniature circuit-breaker switching state
  - AS: ON/OFF
  - FC: tripped

#### Shunt trips (ST)

- Assembly with enclosed screws
- Applicable for voltages of 110 to 415 V AC
- Short-circuit protection through miniature circuit-breakers with  $I_n \geq 16$  A
- Remote tripping of the miniature circuit-breaker

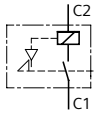

### Selection and ordering data

	Version	MW	Order No.	
	<b>Auxiliary switches (AS)</b> 	1 NO + 1 NC	0.5	5SX9 100
		2 NO		5SX9 101
	<b>Fault signal contacts (FC)</b> 	1 NO + 1 NC	0.5	5SX9 200
	<b>Shunt trips (ST) 100 % duty ratio</b> 		1	5SX9 300

### Dimensional drawings

5SX9 1.., 5SX9 2..

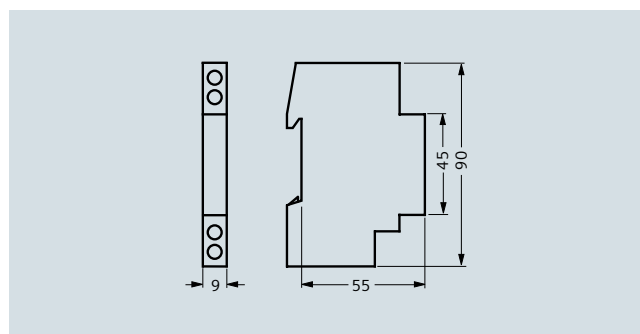

# Betagard Miniature Circuit Breakers & DC Circuit Breakers

Notes

# Betagard Residual Current Devices

Who “nose” where his finger will be tomorrow!

32 Betagard 5SM3 RCCBs

45 Betagard 5SU RCBOs



# Betagard Residual Current Devices

## Betagard 5SM3 RCCBs

### Design, Construction & Features

#### General:

Electricity is usually taken for granted, but any imprudence could be fatal. Damaged insulation and faulty wiring cause a 'Leakage current' to flow to earth. Due to leakage currents, everyday activities like ironing, using a geyser, washing machine, a hair-dryer, an air-conditioner or industrial machinery etc. could turn out to be potentially lethal.

In addition, leakage currents of about 300-500 mA are capable of causing electrical sparks that could cause hazardous fire.

Betagard RCCB is the safest device to detect and trip on leakages and thereby offer instant protection against electrocution and electrical fire. In addition, they prevent energy wastage and thus save on electricity costs.

#### Dangers of Leakage Currents:

1. Direct / Indirect contact with a live parts
2. Electrical fires
3. Energy wastage

#### The solution:

**30mA:** Offers the highest level of protection to human and animal life against direct and indirect contact with live parts.

Recommended for residences, commercial and industrial premises, power sockets, schools, hotels etc, wet areas and during temporary construction installation. Siemens RCCBs trip between 10 to 30 ms, which is nearly 10 times faster than IEC requirements of 200 ms.

**100mA:** Normally provides protection only against indirect contact and hence protects both the entire wiring system and components e.g. in buildings, laboratories, industry, workshops etc. for faults caused through misuse, accidental damage or appliance failure.

**300mA:** Used where only fire protection is required and risk of electric shock is small. It is normal to use 300mA as incomer and subsequent 30mA/100mA protective RCCBs in the downstream circuit.

#### Types of Residual Current Protection Devices

1. Type AC
2. Type A
3. Type B

Suitable RCD type	Circuit	Load current	Residual current
B A AC	1		
	2		
	3		
	4		
	5		
	6		
B A AC	7		
	8		
	9		
	10		

Table 1: Possible residual current wave shapes and suitable residual current protective devices

Type AC:

Residual current protective devices of type AC are suitable only for detecting sinusoidal AC residual current (see circuits 1 to 3 in Table 1). This device type to DIN VDE 0100-530 is not authorized in Germany for residual current protection, and cannot carry the VDE mark of conformity.

Type A:

In addition to sinusoidal AC residual currents, residual current protective devices of type A also measure pulsating DC residual currents.

This device type is the most commonly used pulse current-sensitive residual current operated circuit-breaker. It also covers the residual current waveforms which can occur in power supply units (e.g. ECG, washing machines) in the case of single-phase loads with electronic components. This type of residual current protective device is suitable for electronic resources with input current circuits nos. 1 to 6 in Table 1.

There are further sub types in Type A RCCB s. They are as follows



### Type S, Selective S

### Type K, Super Resistant K

### Type S Selective S

In order to achieve selective tripping in the case of series-connected residual current protective devices in the event of a fault scenario, both the rated residual current  $I_{\Delta n}$  and the tripping time of the devices must be staggered. The different permissible tripping times of the standard and selective residual current protective devices can be taken from Figure 1. The suitable staggering of the rated residual currents can also be seen in Figure below.

Selective residual current protective devices of type S also have a very high surge withstand capability of 5 kA (8/20  $\mu$ s current waveform). They are identified by the symbol S.

### Type K, Super Resistant Short Time - Delayed

As far as the device specification is concerned, there are only two device versions: instantaneous and selective. The "K" versions must therefore fulfill the maximum permissible tripping times for instantaneous devices. Residual current protective devices of type K are slightly delayed (approx. 10 ms for high residual currents).

The tripping times for the "K" versions are therefore somewhat longer as those for the standard devices, for example for residual currents  $> 5 I_{\Delta n}$ : approx. 30 ms instead of around 10 to 15 ms.

They therefore conform to the maximum permissible tripping times (40 ms) for the standard versions (see Figure 2). They are identified by the symbol K.

The layout of the tripping circuit reduces the electrical interference of transient residual currents. This results in an increased surge withstand strength of 3 kA (8/20  $\mu$ s current waveform, see Figure below) compared to the standard version (1 kA). In addition, these RCCB s are insensitive to surge leakage currents, such as those which occur in switched-mode power supplies or filters when capacitors are switched on.

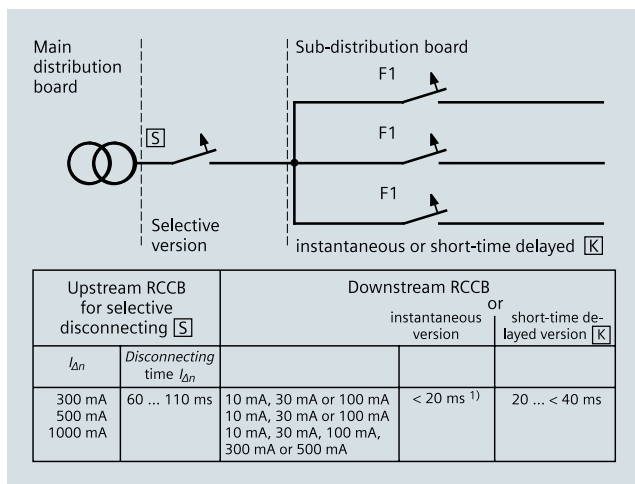

Figure 1: Layout of different residual current protective devices and their tripping times

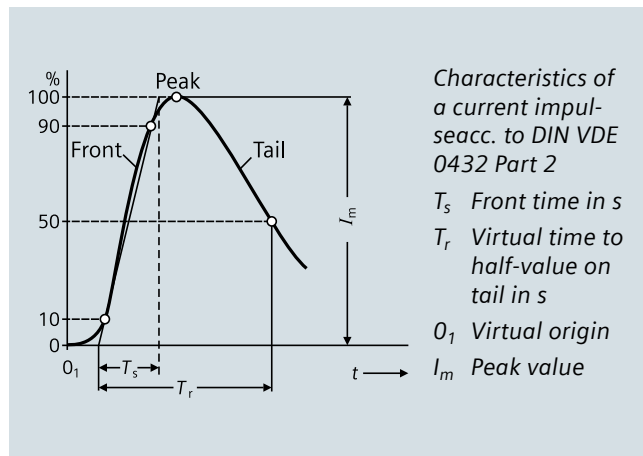

Figure 2: Surge current wave 8/20  $\mu$ s

### Type B: ~ ---

In addition to detecting residual current waveforms of type A, residual current protective devices of type B are used to measure smooth DC residual currents. Residual current operated circuit breakers of this type are suitable for use in three-phase AC systems with 50/60 Hz also upstream of input circuits No. 7 to 10 in Table 1 and therefore for all the circuits shown.

### Breaking capacity:

Every RCCB requires suitable rating backup fuse in order to achieve required breaking capacity. When used along with a MCB  $\geq 10$ kA, no additional back-up fuse is required and are suitable for a network having a prospective short circuit current of 10 kA. (e.g. 5SX4 MCBs)

### Protection against contact welding:

The contacts are made of special silver alloys with a large safety margin. This avoids the danger of Betagard RCCBs getting welded under heavy fault currents. Contacts are also free from Noxious Nickel & Cadmium.

### False tripping avoided:

Travelling surges caused by thunderstorms, lightning, motor switching etc. can cause undesirable tripping of RCCBs. Betagard RCCBs have special filters and pass exacting standards to prevent this occurring.

### Modular N-system:

Being extremely compact with space-saving dimensions, they are fully compatible in modular size to our 'Betagard' MCBs and DBs. Provides IP42 degree of protection within our Double Door DB design.

### Fixed trip setting:

Precision tripping sensitivity (mA) is factory-set at Germany; thus hazardous tampering is prevented.

# Betagard Residual Current Devices

## Betagard 5SM3 RCCBs

### Rugged service life:

After tests comprising 10,000 electrical and mechanical switching cycles at rated current with no negative results, Siemens RCCBs have been found fully usable. Our RCCBs provide reliability even at 95% humidity and at ambient temperature of 45°C. They are also vibration-proof and can be mounted on machinery or mobile vehicles.

### Standards:

Meets the highest technical standards of IEC/EN 61008, VDE 0664 part 10, IEC/EN 61543, VDE 0664 part 30 and IS 12640.

### Quality & testing:

Precision and perfection are the only ways of assuring quality. Siemens RCCBs passes through more than 40 stringent automated tests, before it is considered reliable.

### Other key features:

- Mounting is possible in any position and on temporary structures
- Finger-touch proof terminals for operator safety
- Podzidrive screws for use with any screwdriver (Star/Split)
- Special tunnel terminals ensure perfect cable grip.
- Current-operated mechanism provides maximum reliability
- Snap-on fit to 35mm DIN rail
- Busbar connection also possible
- Auxiliary Contacts for remotely indicating ON/OFF status of RCCB

### Protection against dangerous leakage currents acc. to DIN VDE 0100 Part 410

### Application:

- Protection against indirect contact (indirect personnel protection) – as leakage protection through tripping in the event of higher touch voltages due to short-circuits to frame on equipment
- Using residual current protective devices with  $I_{\Delta n} \leq 30\text{mA}$  also largely protects against direct contact (direct personnel protection) - as additional protection through tripping as soon as live parts are touched.

### Protective action:

While devices for rated residual current  $I_{\Delta n} > 30\text{ mA}$  provide protection again indirect contact, using devices with  $I_{\Delta n} \leq 30\text{mA}$  also offers the best possible additional protection against the accidental direct contact of live parts.

The diagram above shows a summary of the physiological reactions of the human body to power flows in the effective current ranges.

The dangerous values are the current/time values in range 4 as they can trigger ventricular fibrillations, which can cause death.

It also shows the tripping range of the residual current protection device with rated residual current 10mA and 30mA. The tripping time lies in the middle between 10 ms and 30 ms.

The permissible tripping time of max. 0.3 s (300 ms) acc. to VDE 0664 or EN 61008 or IEC 61008 is not reached.

Residual current protective devices with rated residual current 10 or 30 mA also offer reliable protection when a current flows through a person after accidental direct contact with live parts. This protective action is not matched by any other comparable protective measure in the event of indirect contact.

*However, when using residual current protective devices, a suitably grounded PE conductor must also be fitted to the devices and equipment to be protected. This means that it is only possible for a person to be subjected to a flow of current if two faults occur or in the event of accidental contact with live parts.*

If live parts are directly touched, two resistors determine the level of the current - the internal resistance of the person  $R_M$  and the contact resistance of the location  $R_{St}$ . For a proper assessment of the accident risk, the worst case scenario must be assumed, which is that the contact resistance of the location is virtually zero.

The resistance of the human body depends on the current path. Measurements have shown that, e.g. that a current path of hand to hand or hand to foot has a resistance of approx. 1 000  $\Omega$ . Taking into account a fault voltage of 230 V AC, this produces a current of 230 mA for the current path hand to hand.

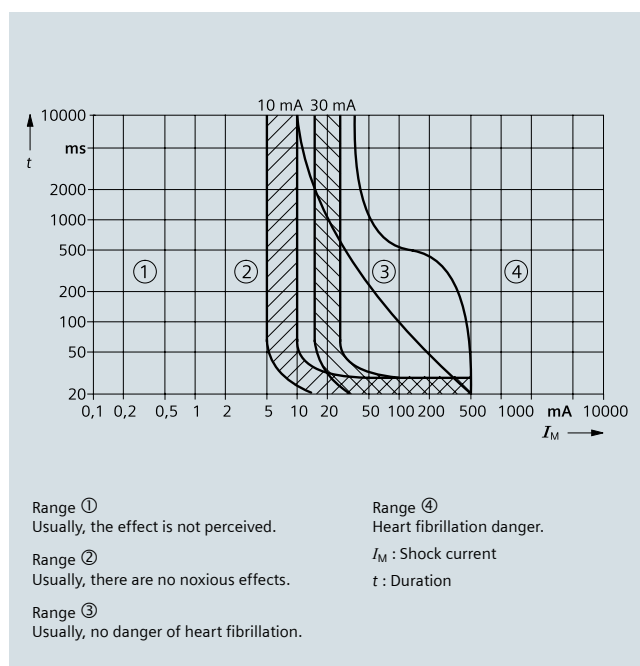

Figure 3: Effective current ranges acc. to IEC 60479

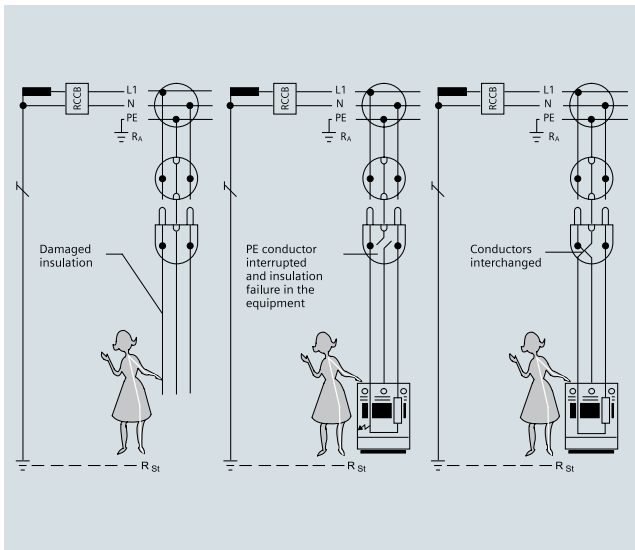

Figure 4: Examples of accidental direct contact

### Usage:

Residual current protective devices can be used in all three system configurations (IEC 364-4-41, HD 384.4.41, DIN VDE 0100-410).

In the IT system, tripping is not required for the first fault as this situation cannot produce any dangerous touch voltages. It is essential that an insulation monitoring device is fitted so that the first fault is indicated by an acoustic or visual signal and the fault can be eliminated as quickly as possible. Tripping is not requested until the 2nd fault.

Depending on the grounding situation, the tripping conditions of the TN or TT system must be complied with. A residual current protective device is also a suitable circuit protective device, whereby a separate residual current protective device is required for each piece of current-using equipment.

### Grounding resistances:

When using residual current protective devices in a TT system, the maximum grounding resistances (as shown in the following table) must be complied with, depending on the rated residual current and the max. permissible touch voltage.

### Fire protection acc. to HD 384.4.482, DIN VDE 0100-482

### Application:

- When using residual current protective devices with  $I_{\Delta n} \leq 300 \text{ mA}$  protection against the occurrence of fires started electrically due to isolation faults

### Protective action:

HD 384.4.482, DIN VDE 0100-482 requires measures to be taken to prevent fires in "Locations exposed to fire hazards" that may result from isolation faults.

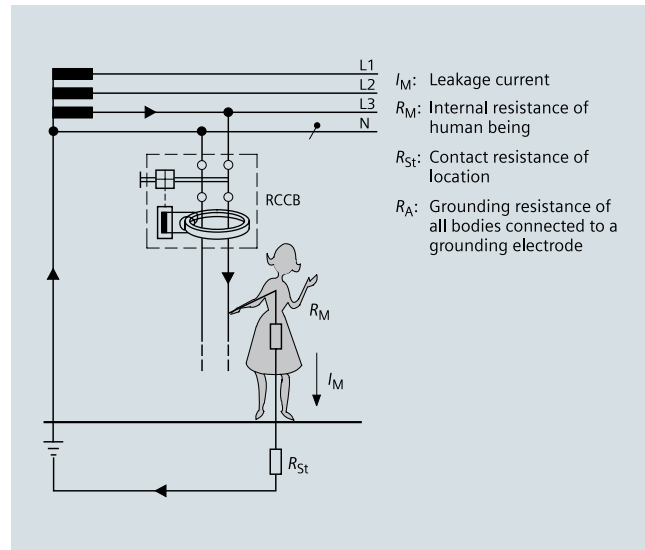

Figure 5: Additional protection against direct contact with live parts

Electrical equipment must be selected and set up taking external influences into account so that their temperature rise during normal operation, and the foreseeable temperature rise, cannot cause a fire in the event of a fault.

This is achieved by ensuring the equipment is suitably designed or by implementing additional safety measures during installation.

For this reason, additional residual current protective devices with a rated residual current of max. 300 mA is required for TN and TT systems used in "Locations exposed to fire hazards".

Where resistance-related faults may cause a fire (e.g. when using ceiling heating with panel heating elements), the rated residual current must not exceed max. 30 mA.

The additional protection against fires provided by separate residual current protective devices should not just be restricted to locations exposed to fire hazards, rather it should be universally implemented. (Ref: Figure 6)

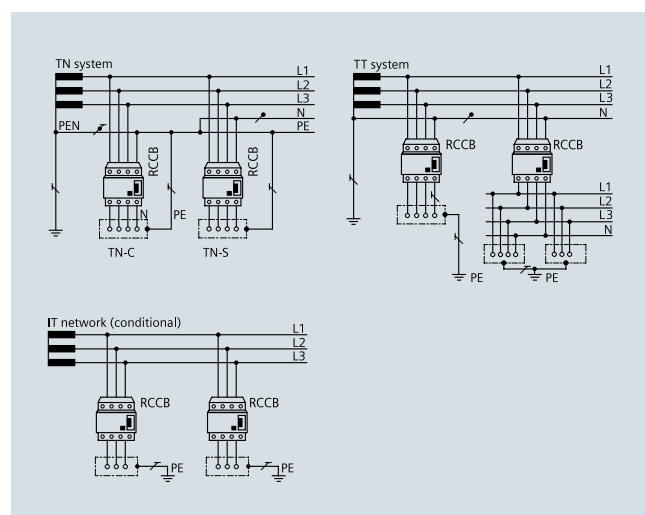

Figure 6:

# Betagard Residual Current Devices

## Betagard 5SM3 RCCBs

### Setup and method of operation of residual current protective devices:

The setup of residual current protective devices is largely determined by 3 function groups:

- 1) Summation current transformers for fault-current detection
- 2) Releases to convert the electrical measured quantities into a mechanical tripping operation
- 3) Breaker mechanism with contacts

The summation current transformer covers all conductors required to conduct the current, i.e. also the neutral conductor where applicable.

In a fault-free system, the magnetizing effects of the conductors through which current is flowing cancel each other out for the summation current transformer as, in accordance with Kirchoff's current law, the sum of all currents is zero. There is no residual magnetic field left that could induce a voltage in the secondary winding.

However, by contrast, if a residual current is flowing due to an insulation fault, this destroys the equilibrium and a residual magnetic field is left in the core of the converter. This generates a voltage in the secondary winding, which then uses the release and the breaker mechanism to switch off the electrical circuit afflicted with the isolation fault.

This tripping principle operates independently of the system voltage or an auxiliary power supply. This is also a condition for the high protection level, offered by residual current protective devices acc. to IEC/EN 61008 (VDE 0664).

Only this way can it be ensured that the full protective action of the residual current protective device is maintained even in the event of a system fault, e.g. failure of an outer conductor or an interruption in the neutral conductor.

### Test button:

You can test whether the residual current protective device is ready to run by simply pressing a test button, with which every residual current protective device is equipped. Pressing the test button generates an artificial residual current - the residual current protective device must trip.

We recommend testing the functionality when commissioning the system and then at regular intervals - approx. every six months. Furthermore, it is also essential to ensure compliance with the test intervals specified in the pertinent rules and regulations (e.g. accident prevention regulations).

The minimum working voltage for operation of the test equipment normally is 100 V AC (series 5SM).

Rated residual current $\Delta_{Dn}$	Max. permissible grounding resistance at a max. permissible touch voltage of	
	50 V	25 V
10 mA	5000 $\Omega$	2500 $\Omega$
30 mA	1660 $\Omega$	830 $\Omega$
100 mA	500 $\Omega$	250 $\Omega$
300 mA	166 $\Omega$	83 $\Omega$
500 mA	100 $\Omega$	50 $\Omega$
1 A	50 $\Omega$	25 $\Omega$

### Distribution Networks:

Betagard RCCBs can be used in all 3 distribution network types viz. TN, TT & an IT network system. 4 pole RCCBs can also be used in 3 pole supply networks by adhering to installation guidelines.

### 3-pole connection:

4-pole residual current protective devices can also be operated in 3-pole systems. In this case, connection must be at terminals 1, 3 and 5 and 2, 4 and 6.

The function of the test equipment is only ensured if a jumper is fitted between terminals 3 and N. (Ref: Figure 7)

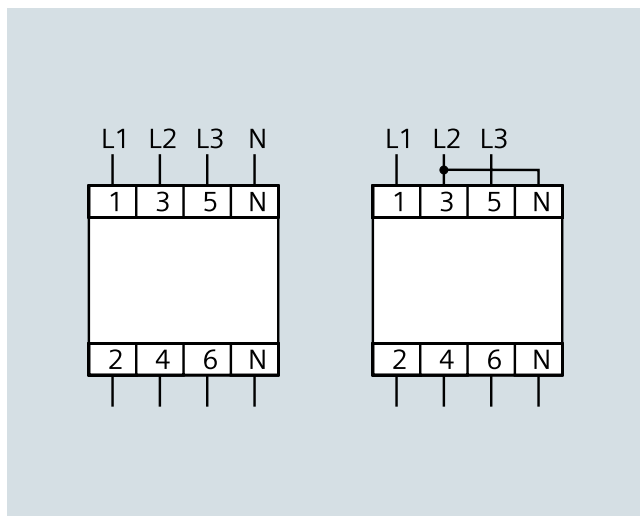









Figure 7:

# Betagard Residual Current Devices

## Betagard 5SM3 RCCBs

Type of current	Current waveform	Correct function of residual current protective devices of type			Tripping current <sup>1)</sup>
		Type AC 	Type A 	Type B 	
AC residual current		✓	✓	✓	0.5 ... 1.0 $I_{\Delta n}$
Pulsating DC residual currents (pos. or neg. half-waves)		–	✓	✓	0.35 ... 1.4 $I_{\Delta n}$
Started half-wave currents Start angle 90° el Start angle 135° el		–	✓ ✓	✓ ✓	0.25 ... 1.4 $I_{\Delta n}$ 0.11 ... 1.4 $I_{\Delta n}$
Half-wave current during superimposition with smooth direct current of 6 mA		–	✓	✓	max. 1.4 $I_{\Delta n}$ + 6 mA
Smooth direct current		–	–	✓	0.5 ... 2.0 $I_{\Delta n}$

<sup>1)</sup> Tripping currents according to IEC/EN 61008-1 (VDE 0664, Part-10); for smooth DC residual currents defined to IEC 60755 UB1 INT.



# Betagard Residual Current Devices

## Betagard 5SM3 RCCBs

### Recommendations for RCCB Selection

Application	Required $I_{\Delta n}$ [mA]	Recommended residual current protective devices		
		5SM (Type AC)	5SM (Type A)	5SM (Type B)
Socket outlet $\leq 20A$ and branch circuits for out door use $\leq 32A$	$\leq 30$	✓	✓	–
Fire protection for particular risks or safety hazard	30, 300	✓	✓	✓
Low Voltage Generating Sets	$\leq 30$	–	✓	–
Luminaries and lighting installations, display stands for lights	$\leq 30$	✓	✓	–
Rooms with baths or showers, socket outlets in zone 3	$\leq 30$	✓	✓	–
Swimming Pools, zone 1 and 2	$\leq 30$	✓	✓	–
Construction and demolition site installations, socket outlet current circuits (single-phase operation) up to 32A and for hand-held equipment	$\leq 30$	✓ ✓	– ✓	– ✓
Agricultural and general horticultural premises	$\leq 500$	–	✓	–
Socket outlet current circuits	$\leq 30$	✓	✓	–
Conductive areas with limited freedom of movement	$\leq 30$	✓	✓	–
Feeding points for caravan parking spaces, camping sites	$\leq 30$	✓	✓	–
Medical Premises, depending on application group 1 or 2 and equipment	$\leq 30$ or $\leq 300$	–	✓	✓
Classroom with experiment equipment	$\leq 30$	–	–	✓
Fountain Zones 2, General	$\leq 500$	–	✓	–
Socket outlets in Zone 2	$\leq 30$	✓	✓	–
Zones 0 and 1	$\leq 30$	✓	✓	–
Additional Protection against direct contact in homes	$\leq 30$	✓	✓	–
Mining Plants	$\leq 500$	–	✓	–
Finding of power installations with electronic equipment	General requirements for correct selection when using res. Current protection	✓	✓	✓
Traffic Signals - Class T1 - Class U1	$\leq 300$ $\leq 30$	✓ ✓	✓ ✓	– –
Selection and Operation of electrical equipment at worksites General: Socket outlet circuits $\leq 32A$ Socket outlet circuits $> 32A$ Frequency Controlled Equipment: With Plug and socket device $\leq 32A$ With Plug and socket device $> 32A$	$\leq 30$ $\leq 500$ $\leq 30$ $\leq 500$	✓ ✓	✓ ✓	✓ ✓ ✓ ✓
Chemical Industry and food processing industries	30 recommended	✓	✓	✓

Note:

For Reasons of Basic fire protection, we recommend a maximum rated residual current of 300mA for residual current protection devices.

### Technical Specifications



<b>Standards</b>	IS 12640 Part 1, IEC/EN 61008, VDE 0664 Part 10, IEC/EN 61543, VDE 0664 Part 30		
<b>Versions</b>	DP and FP		
<b>Rated Voltage <math>U_n</math></b>	V AC	125...240 230...415	50...60Hz 50...60Hz
<b>Rated Current <math>I_n</math></b>	A	25, 40, 63, 80, 100, 125	
<b>Rated Residual Currents <math>I_{\Delta n}</math></b>	mA	30, 100, 300, 500	
<b>Enclosure</b>	Grey Moulded Plastic (RAL 7035)		
<b>Mounting Depth</b>	mm	70	
<b>Terminals</b>	Tunnel terminals at both ends with wire protection, lower combined terminal for simultaneous connection of busbars (fork type) and conductors		Conductor Cross-Section mm <sup>2</sup>
	For 2 MW	at $I_n = 25A, 40A$ at $I_n = 100A, 125A$	1.0...16 1.5...50
	For 2.5 MW	at $I_n = 63A, 80A$	1.5...25
	For 4 MW	at $I_n = 25A, 40A, 63A, 80A$ at $I_n = 125A$	1.5...25 2.5...50
			Recommended terminal tightening Torque Nm 2.5...3.0 3.0...3.5 2.5...3.0 2.5...3.0 3.0...3.5
<b>Surge Current Withstand capacity of RCCB s</b>	With Current Wave Form 8/20 $\mu$ s		
<b>Instantaneous</b>	1 kA		
<b>Super Resistant K</b>	3 kA		
<b>Selective S</b>	5 kA		
<b>Supply Connection</b>	Optionally Top or Bottom		
<b>Mounting position</b>	Any		
<b>Mounting Technique</b>	Can be snapped onto standard mounting rail 35mm (TH 35 acc. to EN 60715)		
<b>Degree of Protection</b>	IP 20 acc. to EN 60529 (VDE 0470 Part 1) IP 40 for installation in distribution boards		
<b>Protection against Contact</b>	Protection against contact of fingers or the back of the hand acc. to EN 50274 (VDE 0660 Part 514)		
<b>Minimum operating Voltage for test function operation</b>	V AC	100	
<b>Device Service Life</b>	> 10,000 operations (electrical and mechanical; Test cycle acc. to regulations)		
<b>Storage Temperature</b>	°C	-40...+75	
<b>Ambient Temperature</b>	°C	-40...+75 For versions with the symbol  : -25...+45	
<b>Resistance to Climate acc. to IEC 60068-2-30</b>	28 Cycles (55 °C; 95% relative humidity)		
<b>CFC and Silicon free</b>	Yes		

# Betagard Residual Current Devices

## Betagard 5SM3 RCCBs

### Product Overview

#### Type A & Type AC

	Rated residual current $I_n$ (mA)	Rated current $I_n$ (A)	MW#	Reference No. Type A	Reference No. Type AC	Std. Pkg. (Nos.)
	<b>2 Pole</b>					
	30	25	2	5SM33126RC	5SM33120RC	1
	100	25		5SM34126RC	5SM34120RC	1
	300	25		5SM36126RC	5SM36120RC	1
	30	40		5SM33146RC	5SM33140RC	1
	100	40		5SM34146RC	5SM34140RC	1
	300	40		5SM36146RC	5SM36140RC	1
	30	63	2.5	5SM33166RC	5SM33160RC	1
	100	63		5SM34166RC	5SM34160RC	1
	300	63		5SM36166RC	5SM36160RC	1
	30	80		5SM33176RC	5SM33170RC	1
	100	80		5SM34176RC	5SM34170RC	1
	300	80		5SM36176RC	5SM36170RC	1
	30	100	2	5SM33186KK	5SM33180KK	1
	100	100		5SM34186KK	5SM34180KK	1
	300	100		5SM36186KK	5SM36180KK	1
	30	125		5SM33156KK	5SM33150KK	1
	100	125		5SM34156KK	5SM34150KK	1
300	125	5SM36156KK		5SM36150KK	1	
	<b>4 Pole</b>					
	30	25	4	5SM33426RC	5SM33420RC	1
	100	25		5SM34426RC	5SM34420RC	1
	300	25		5SM36426RC	5SM36420RC	1
	30	40		5SM33446RC	5SM33440RC	1
	100	40		5SM34446RC	5SM34440RC	1
	300	40		5SM36446RC	5SM36440RC	1
	30	63		5SM33466RC	5SM33460RC	1
	100	63		5SM34466RC	5SM34460RC	1
	300	63		5SM36466RC	5SM36460RC	1
	30	80		5SM33476RC	5SM33470RC	1
	100	80		5SM34476RC	5SM34470RC	1
	300	80		5SM36476RC	5SM36470RC	1
	30	100		5SM33486RC	5SM33480RC	1
	100	100		5SM34486RC	5SM34480RC	1
	300	100		5SM36486RC	5SM36480RC	1
	30	125		5SM33456RC	5SM33450RC	1
	100	125		5SM34456RC	5SM34450RC	1
300	125	5SM36456RC		5SM36450RC	1	
500	125		5SM37456RC	5SM37450RC	1	







# Betagard Residual Current Devices

## Betagard 5SM3 RCCBs

### Product Overview

#### Type A

		Rated residual current $I_n$ (mA)	Rated current $I_n$ (A)	MW#	Reference No.	Std. Pkg. (Nos.)		
<b>Super Resistant K</b>								
	2 Pole	30	25	2	5SM33126RC01	1		
		30	40		5SM33146RC01	1		
	2.5	30	63	2.5	5SM33166RC01	1		
		300	63		5SM36166RC01	1		
		4 Pole	30		25	4	5SM33426RC01	1
			30		40		5SM33446RC01	1
	300		40	5SM36446RC01	1			
	30		63	5SM33466RC01	1			
	300		63	5SM36466RC01	1			
	300	80	5SM36476RC01	1				
<b>Selective S</b>								
	2 Pole	300	40	2	5SM36148RC	1		
		100	63		2.5	5SM34168RC	1	
		300	63			5SM36168RC	1	
		300	80			5SM36178RC	1	
	4 Pole	100	40	4	5SM34448RC	1		
		300	40		5SM36448RC	1		
		100	63		5SM34468RC	1		
		300	63		5SM36468RC	1		
		300	125		5SM36458RC	1		
		500	125		5SM37458RC	1		





# Betagard Residual Current Devices

## Betagard 5SM3 RCCBs

### Product Overview

#### Type B

		Rated residual current $I_n$ (mA)	Rated current $I_n$ (A)	MW#	Reference No.	Std. Pkg. (Nos.)
<b>Super Resistant K</b>						
	4 Pole	30	25		5SM33424RC	1
		300	25		5SM36424RC	1
		30	40		5SM33444RC	1
		300	40		5SM36444RC	1
		30	63		5SM33464RC	1
		300	63		5SM36464RC	1
		500	63		5SM37464RC	1
		30	80		5SM33474RC	1
		300	80		5SM36474RC	1
		500	80		5SM37474RC	1
<b>Selective S</b>						
	4 Pole	300	63	4	5SM36465RC	1
		500	63		5SM37465RC	1
		300	80		5SM36475RC	1
		500	80		5SM37475RC	1



### Additional Components

#### Benefits:

- An auxiliary circuit switch can be fitted to the right-hand side of the RCCB casing by the customer
- Mounting with factory-fitted brackets
- Ideal for installation in flat distribution boards



#### Application:

- Remote indications of the circuit state of the RCCB: ON/OFF
- Short-circuit protection ensured by miniature circuit-breakers of C characteristic with  $I_n = 6\text{ A}$  or fuse gL6A
- Product standards: IEC/EN 62019 (VDE 0640).

### Technical specifications:

		5SW3300	5SW3330
<b>Terminals</b>			
• Conductor cross section	mm <sup>2</sup>	0.75 ... 2.5	0.75 ... 2.5
• Recommended tightening torque	Nm	0.6 ... 0.8	0.6 ... 0.8
<b>Min. contact load</b>		50 mA/24 V	50 mA/24 V
<b>Max. contact load</b>			
• 240 V AC, AC-12	A	6	5
• 240 V AC, AC-14	A	3.6	–
• 220 V DC, DC-12	A	1	0.5

### Selection and ordering data:

	Circuit diagram	Version	MW	Order No.	Weight 1 item kg	PS*/P. unit Items
	<b>Auxiliary switches (AS)</b> For 5SM3 RCCBs upto 80A 	1 NO + 1 NC	0.5	5SW3300	0.042	1
	<b>Auxiliary switches (AS)</b> For 5SM3 RCCBs 100 ... 125A 	1 NO + 1 NC	0.5	5SW3330	0.040	1

1 MW = 18 mm

# Betagard Residual Current Devices

## Betagard 5SM3 RCCBs

### Dimensions

#### RCCB up to 80 A

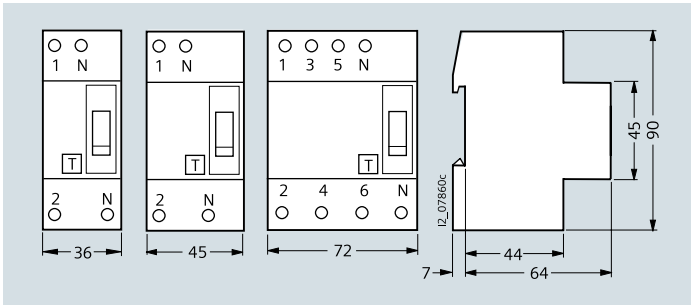

2P      2P      4P  
2MW    2.5MW    4MW

MW = 2	MW = 2.5	MW = 4
25A/2P	63A/2P	25A/4P
40A/2P	80A/2P	40A/4P
		63A/4P
		80A/4P

#### RCCBs 100 and 125 A

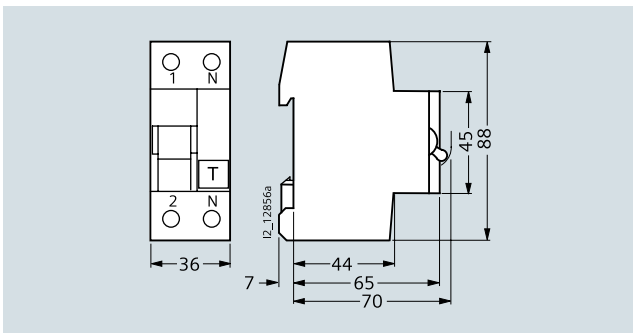

2P, 2 MW

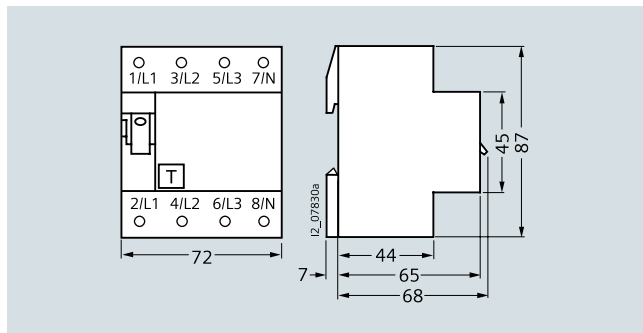

4P, 4 MW

#### 5SW3 auxiliary circuit switches, can now be retrofitted at site

Auxiliary switches (AS)  
for RCCBs for 5SM3 up to 80 A

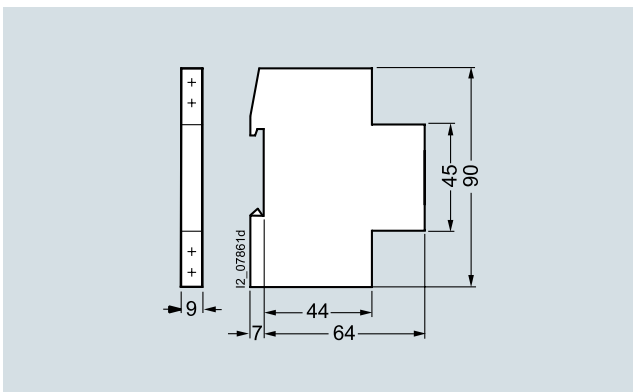

Auxiliary switches (AS)  
for RCCBs for 5SM3, 100A, 125A, 3P+N

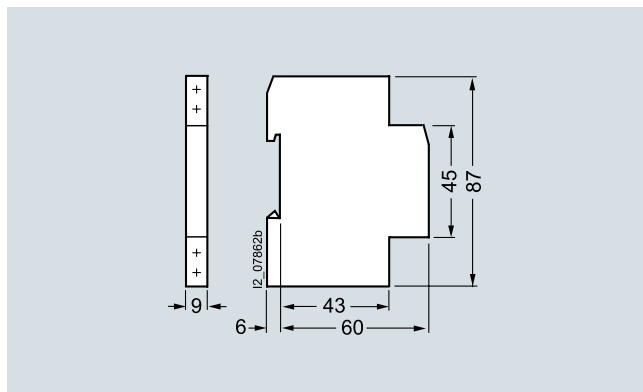

### Overview

The resistance of a human body to current depends on the current path. Measurements have shown that, a current path of hand/hand or hand/foot has a resistance of approx.  $1000\Omega$ , taking into account a fault voltage of 230V AC, this produces a current of 230mA for the current path hand/hand.

Three function groups largely determine the setup of residual current protective devices:

- a. Summation current transformers for fault current detection
- b. Releases to convert the electrical measured quantities into a mechanical tripping operation
- c. Breaker mechanism with contacts

The summation current transformer covers all conductors required to conduct the current, i.e. also the neutral conductor where applicable.

In a fault free system, the magnetizing effects of the conductors through which current is flowing cancel each other out for the summation current transformer, as the sum of all currents is zero. There is no residual magnetic field left that could induce a voltage in the secondary winding. However, by contrast, if a residual current is flowing due to an isolation fault, this destroys the equilibrium and a residual magnetic field is left in the core of the converter. This generates a voltage in the secondary winding, which then uses the release and the breaker mechanism to switch off the electrical circuit afflicted with the isolation fault. This tripping principle operates independently of the system voltage or an auxiliary power supply. This way it can be ensured that the full protective action of the residual current protective device is maintained even in the event of a system fault.

Due to the use of electronic components in household appliances and industrial plants, insulation faults can also cause residual currents that are not AC residual currents to flow through residual current protective devices, even in the case of devices with ground terminals.

The basic prerequisite for use of a residual current protective device is the running of a grounded PE conductor to the components and equipment to be protected. A current flow can then pass through a human body only when two faults occur (1) Interruption of the PE conductor in addition to the insulation fault or (2) When there is unintentional contact with live parts.

Residual current protective devices offer protection against

1. Direct contact – Direct contact is considered as direct contact of a human body with a live part.
2. Indirect contact (fault protection) – Indirect contact is considered as the contact of a human body with a de-energized, electrically conductive part. In these cases, the demand is for automatic interruption of the power supply when a fault can pose a risk due to the intensity and duration of the touch voltage.

3. Fire protection – For locations exposed to fire hazards, residual current protective devices should offer earth leakage protection for the prevention of fires, which may originate from insulation faults.

### Types of residual current protective devices

1. Type AC – Residual current protective devices of type AC are suitable only for detecting sinusoidal AC residual currents.
2. Type A – In addition to AC sinusoidal currents, residual current protective devices of type A also measure pulsating DC residual currents. e.g. applications like ECGs, washing machines, fax machines etc. having electronic components.

Betagard RCBOs have the unique distinction of combining the earth leakage protection function of an RCCB with the overload and short circuit function of MCB.

Betagard RCBO (2P, 2M) is available from 6 to 40A in 1Pole+Neutral version. The device has a breaking capacity of 10kA as per IEC60898 and is available in 2 Module width size.

This RCBO can be used for personnel as well as fire protection:

- $I_{\Delta n} \leq 30\text{mA}$ : Additional protection in the case of direct contact
- $I_{\Delta n} \leq 300\text{mA}$ : Preventive fire protection in the case of ground fault currents

Betagard RCBOs are also offered combination devices, which offer overcurrent protection for overload and short circuit protection in addition to protection against residual currents. A version in this device group is a residual current block (RC unit) combined to a miniature circuit breaker (selected on the basis of characteristic & rated current) to form a RCBO. These devices are factory assembled and offer the same functions as RCBO. The RC unit has no contacts of its own; in the event of a fault, it trips the circuit breaker, which opens the contacts and interrupts the circuit.

Betagard RCBOs are available in 4 standard versions from 32A to 63A. They offer 10kA-breaking capacity as per IS8828 in 2P and 4P versions.

1. MCB C characteristics with RC unit Type AC
2. MCB C characteristics with RC unit Type A
3. MCB D characteristics with RC unit Type AC
4. MCB D characteristics with RC unit Type A

# Betagard Residual Current Devices

## Betagard 5SU RCBOs

### Technical specifications

#### Technical specifications (5SU1 RCBOs)

Standards	IS 12640-2 (2008), IEC 61009, VDE 0664 Part 20/Part 30, IEC 61543
No. of Poles	1 Pole + N, 2P, 4P
Rated voltages, Un (V)	125...240V AC, 50...60Hz; 240V / 415 V AC 50...60Hz
Rated currents, In (A)	6, 10, 16, 20, 25, 32, 40, 63
Rated residual currents (mA)	30, 100, 300
Rated short circuit capacity (kA)	10
Tripping characteristics	C, D
Energy limiting class	3
Enclosure	Gray molded plastic (RAL 7035)
Mounting depth (mm)	70
Terminals	
1. Conductor cross section (sqmm)	1... 25
2. Terminal tightening torque (Nm)	2.5... 3
Supply connection	Either top or bottom
Mounting position	Any
Mounting technique	Can be snapped on to a 35mm DIN rail
Degree of protection	IP20 acc to EN60529 (VDE 0470 Part 1) IP40/IP42 for installation in distribution boards
Minimum operating voltage for test function operation (V)	195V AC
Device service life	> 10,000 operations (electrical and mechanical)
Storage temperature (°C)	-40... +75
Ambient temperature (°C)	-25... +45
CFC and silicon free	Yes

### Product Overview

#### Betagard Residual Current Breaker Operators - 5SU1, 10kA

Un 240Vac, 50...60Hz

Product Standards: IS 12640, Part 2/IEC 61009-1

With ISI marking : CM/L No. 7676193



#### Type AC, applicable in networks for AC residual currents

	Rated residual current $I_n$ (mA)	Rated current $I_n$ (A)	MW#	Reference No.	Std. Pkg. (Nos.)	
	1 pole + N	30	6	2	5SU13541RC06	1/10
		30	10		5SU13541RC10	1/10
		30	16		5SU13541RC16	1/10
		30	20		5SU13541RC20	1/10
		30	25		■ 5SU13541RC25	1/10
		30	32		■ 5SU13541RC32	1/10
		30	40		■ 5SU13541RC40	1/10
		300	6		5SU16541RC06	1/10
		300	10		5SU16541RC10	1/10
		300	16		5SU16541RC16	1/10
		300	20		5SU16541RC20	1/10
		300	25		5SU16541RC25	1/10
		300	32		5SU16541RC32	1/10
		300	40		5SU16541RC40	1/10

#### Type A, applicable in networks with AC residual currents and/or pulsating DC currents

	Rated residual current $I_n$ (mA)	Rated current $I_n$ (A)	MW#	Reference No.	Std. Pkg. (Nos.)	
	1 pole + N	30	6	2	5SU13547RC06	1/10
		30	10		5SU13547RC10	1/10
		30	16		5SU13547RC16	1/10
		30	20		5SU13547RC20	1/10
		30	25		5SU13547RC25	1/10
		30	32		5SU13547RC32	1/10
		30	40		5SU13547RC40	1/10
		300	6		5SU16547RC06	1/10
		300	10		5SU16547RC10	1/10
		300	16		5SU16547RC16	1/10
		300	20		5SU16547RC20	1/10
		300	25		5SU16547RC25	1/10
		300	32		5SU16547RC32	1/10
		300	40		5SU16547RC40	1/10

#### Type AC with C characteristic

	Rated residual current $I_{\Delta n}$ (mA)	Rated current $I_n$ (A)	MW#	Reference No.	Std. Pkg. (Nos.)
	240Vac; 50...60Hz; 2 pole		4	5SU13241RC32 5SU13241RC40 5SU13241RC63 5SU14241RC32 5SU14241RC40 5SU14241RC63 5SU16241RC32 5SU16241RC40 5SU16241RC63	1/10 1/10 1/10 1/10 1/10 1/10 1/10 1/10 1/10
	30	32			
		40			
		63			
	100	32			
		40			
		63			
	300	32			
		40			
		63			
	415Vac; 50...60Hz; 4 pole		7	5SU13441RC32 5SU13441RC40 5SU13441RC63 5SU14441RC32 5SU14441RC40 5SU14441RC63 5SU16441RC32 5SU16441RC40 5SU16441RC63	1/5 1/5 1/5 1/5 1/5 1/5 1/5 1/5 1/5
	30	32			
		40			
		63			
	100	32			
		40			
		63			
	300	32			
		40			
		63			

Note: ■ Stock Items



# 1MW (Module Width) = 18mm

# Betagard Residual Current Devices



## Betagard 5SU RCBOs

### Product Overview



#### Type AC with D characteristic

	Rated residual current $I_{\Delta n}$ (mA)	Rated current $I_n$ (A)	MW#	Reference No.	Std. Pkg. (Nos.)				
	240Vac; 50...60Hz; 2 pole		4	5SU13242RC32 5SU13242RC40 5SU13242RC63 5SU14242RC32 5SU14242RC40 5SU14242RC63 5SU16242RC32 5SU16242RC40 5SU16242RC63	1/10 1/10 1/10 1/10 1/10 1/10 1/10 1/10 1/10				
	30	32 40 63							
	100	32 40 63							
	300	32 40 63							
		415Vac; 50...60Hz; 4 pole				7	5SU13442RC32 5SU13442RC40 5SU13442RC63 5SU14442RC32 5SU14442RC40 5SU14442RC63 5SU16442RC32 5SU16442RC40 5SU16442RC63	1/5 1/5 1/5 1/5 1/5 1/5 1/5 1/5 1/5	
		30							32 40 63
		100							32 40 63
		300							32 40 63

#### Type A with C characteristic

	Rated residual current $I_{\Delta n}$ (mA)	Rated current $I_n$ (A)	MW#	Reference No.	Std. Pkg. (Nos.)				
	240Vac; 50...60Hz; 2 pole		4	5SU13247RC32 5SU13247RC40 5SU13247RC63 5SU14247RC32 5SU14247RC40 5SU14247RC63 5SU16247RC32 5SU16247RC40 5SU16247RC63	1/10 1/10 1/10 1/10 1/10 1/10 1/10 1/10 1/10				
	30	32 40 63							
	100	32 40 63							
	300	32 40 63							
		415Vac; 50...60Hz; 4 pole				7	5SU13447RC32 5SU13447RC40 5SU13447RC63 5SU14447RC32 5SU14447RC40 5SU14447RC63 5SU16447RC32 5SU16447RC40 5SU16447RC63	1/5 1/5 1/5 1/5 1/5 1/5 1/5 1/5 1/5	
		30							32 40 63
		100							32 40 63
		300							32 40 63

#### Type AC with D characteristic

	Rated residual current $I_{\Delta n}$ (mA)	Rated current $I_n$ (A)	MW#	Reference No.	Std. Pkg. (Nos.)				
	240Vac; 50...60Hz; 2 pole		4	5SU13248RC32 5SU13248RC40 5SU13248RC63 5SU14248RC32 5SU14248RC40 5SU14248RC63 5SU16248RC32 5SU16248RC40 5SU16248RC63	1/10 1/10 1/10 1/10 1/10 1/10 1/10 1/10 1/10				
	30	32 40 63							
	100	32 40 63							
	300	32 40 63							
		415Vac; 50...60Hz; 4 pole				7	5SU13448RC32 5SU13448RC40 5SU13448RC63 5SU14448RC32 5SU14448RC40 5SU14448RC63 5SU16448RC32 5SU16448RC40 5SU16448RC63	1/5 1/5 1/5 1/5 1/5 1/5 1/5 1/5 1/5	
		30							32 40 63
		100							32 40 63
		300							32 40 63



### Additional components

#### Auxiliary circuit switch/fault signal contact for 5SU1

##### Benefits

- Can be retrofitted individually  
(For mounting concept and more technical details refer MCB accessories section)

##### Application



Indication of the miniature circuit-breaker's switching state:

- AS: ON/OFF
- FC: tripped

##### Design

- Min contact load: 50 mA, 24 V

### Selection and ordering data

	Version	MW	Order No.	Weights 1 item kg	PS*/ P unit Items
	<b>Auxiliary circuit switches (AS)</b> 	for small output 1 NO + 1 NC	0.5	<b>5ST3 010</b>	0.050 10
	<b>Fault signal contacts (FC)</b> 	1NO + 1 NC	0.5	<b>5ST3 020</b>	0.050 10

# Betagard Residual Current Devices

## Betagard 5SU RCBOs

### Additional components

#### Shunt trip/undervoltage release for 5SU1

##### Benefits

##### Shunt release

- Can be retrofitted individually (For more technical details refer MCB accessories section)
- Suitable for voltages:  
110 to 415 V AC, 110 V AC  
24 to 48 V AC/DC

##### Undervoltage releases

- Can be retrofitted individually (For more technical details refer MCB accessories section)
- Suitable for voltages:  
230 V AC  
110 V DC  
24 V DC

##### Application



##### Shunt release

- Remove tripping of the miniature circuit-breaker

##### Undervoltage releases

- Applicable as remote trip in an EMERGENCY-OFF loop
- Ensures disconnection of the control circuit acc. to EN 60204
- In cases of interrupted or insufficient voltage, the undervoltage release trips the miniature circuit-breaker or prevents it from switching on.

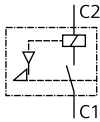
### Selection and ordering data

	Rated voltage $U_n$	MW	Order No.	Weights 1 item kg	PS*/ P unit Items	
	<b>Shunt trips (ST)</b>					
		110 ... 415 V AC	1	<b>5ST3 030</b>	0.098	1/5
		24 ... 48 V AC/DC	1	<b>5ST3 031</b>	0.098	1/5
	<b>Undervoltage releases (UR)</b>					
		230 V AC	1	<b>5ST3 043</b>	0.115	1/5
		24 V DC		<b>5ST3 045</b>	0.115	1/5

### Mounting concept

Using this mounting concept, all additional 5ST3 components can be combined with residual current breaker operators of 5SU1 series:

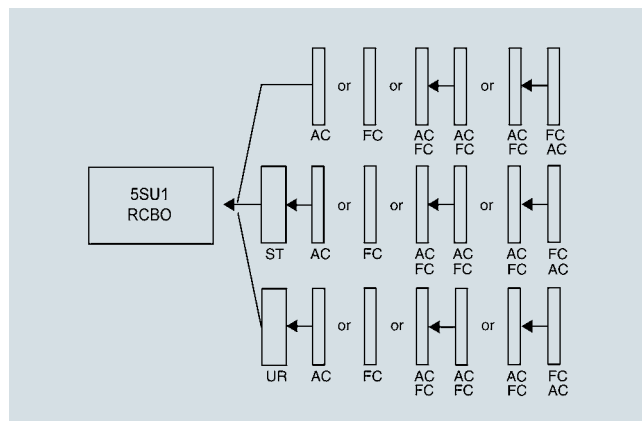

### Dimensions

#### 2P-2M

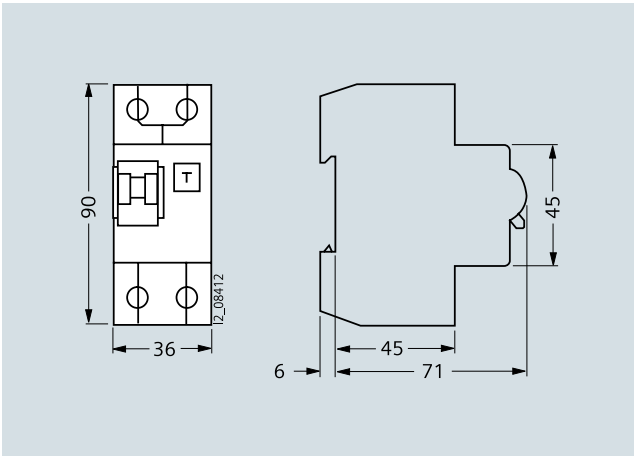

#### 2P-4M

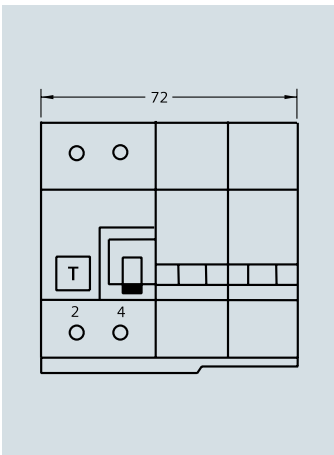

#### 4P-7M

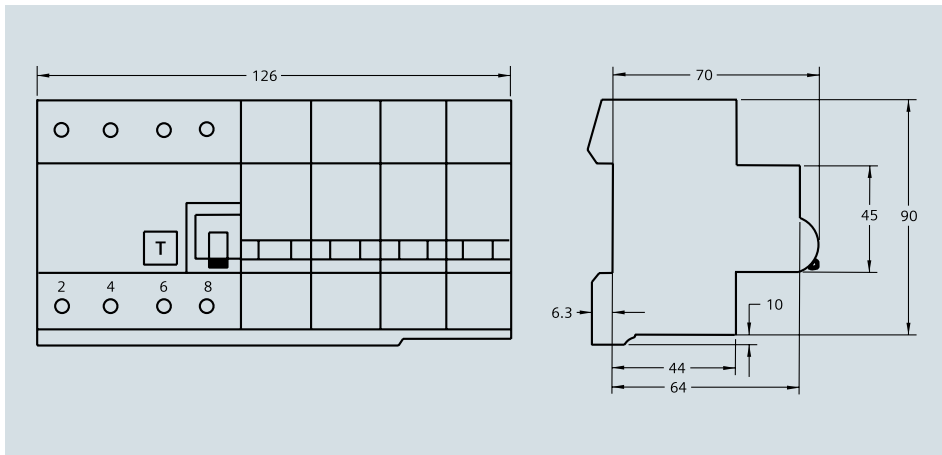

### Add-on components

*Auxiliary contact /  
Fault signal contact*

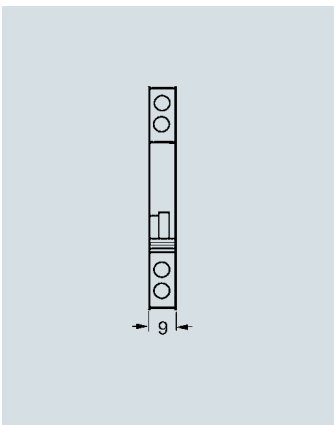

*Shunt trip / undervoltage release*

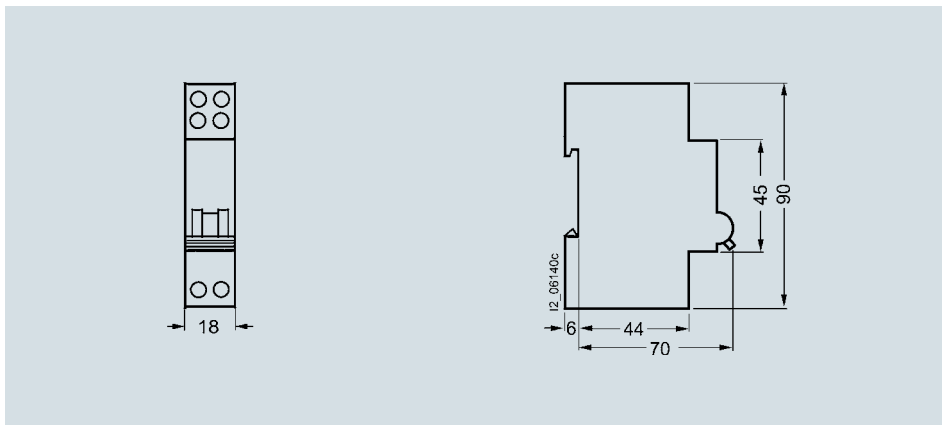

# Betagard Residual Current Devices

Notes

# Betagard Distributions Boards

**Proven reliability now  
with enhanced aesthetics**



54 Betagard 8GB32 SPN & TPN DBs

68 Betagard 4in1 Appliance Protector and Industrial Plug and Socket DBs

72 Betagard 8GB31 DBs

87 Simbox WP



# Betagard Distributions Boards

## Betagard 8GB32 SPN & TPN DBs

### Overview:

Siemens introduces the all new Range of Betagard SPN and TPN Distribution Boards. Synonymous to BETAGARD – “Inspiring Safety” Distribution Boards are studded with various features for safety and aesthetics; providing

numerous benefits to users. With new design, great features, and high aesthetic appeal Siemens offers a highly reliable, safe and a user friendly Distribution board to its users.

### Features / Benefits:

The new Range of Siemens Betagard SPN and TPN DBs are ergonomically designed to deliver a high aesthetic appeal post installation. DBs with it's unique features offer great benefits to it's users with respect to safety and ease of use during installation and maintenance.



- DBs are stylish and suit any décor. It gels well with any wall color and is a natural choice for top architects, builders and also the modern residential user.

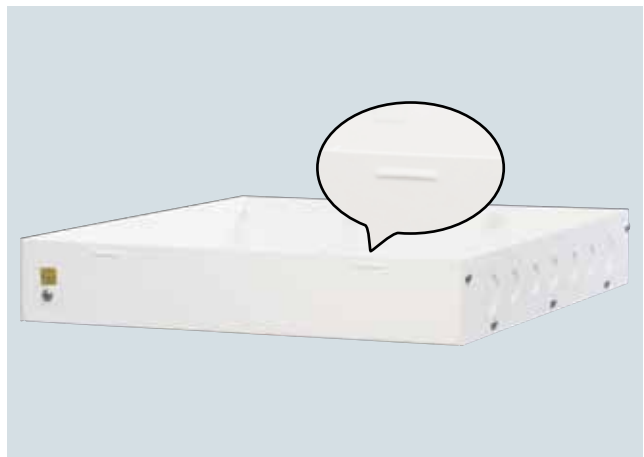

- A unique flush level marking is provided on the U box which guides the installer on the adequate mounting depth during installation.



- Adequate number of knock-outs of various size are provided on detachable gland plates both at the top and at the bottom side of the U plate, this enables easy connection of conduits of all sizes into the DB.

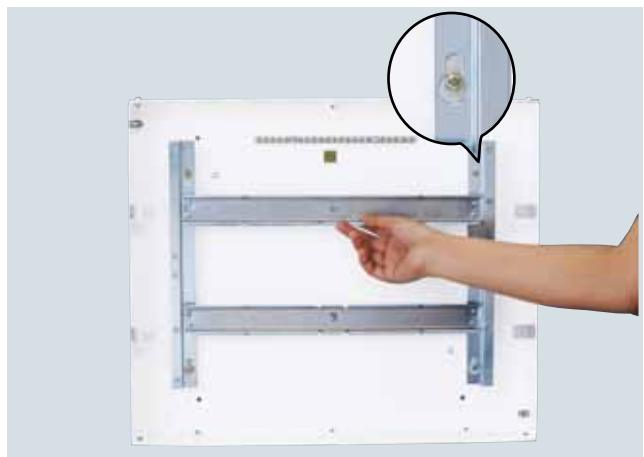

- The DIN rail assembly is easily removable with a keyhole arrangement; thereby it helps in faster assembly and wiring of the devices to be mounted in the DB. The design also offers a uniform look of the components when the door is opened.

# Betagard Distributions Boards

## Betagard 8GB32 SPN & TPN DBs

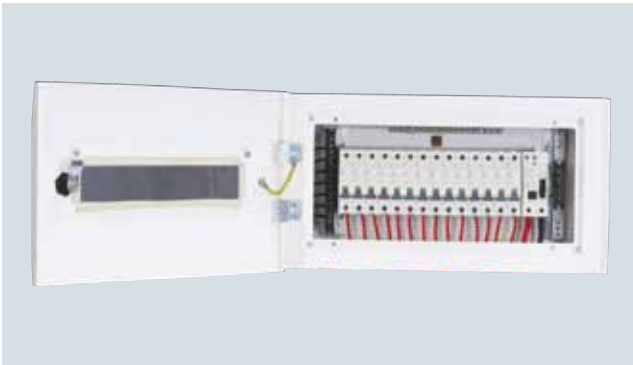

- The optimum space provided in the DB ensures clean installation of the components with the neat wiring.



- A 4sq mm insulated colored wire provides the door earthing, ensuring safety against electrical shocks for the user and operator.



- Shrouded Neutral Link with Terminal Cover ensures safe wiring. Shorting Links are insulated for enhanced safety.

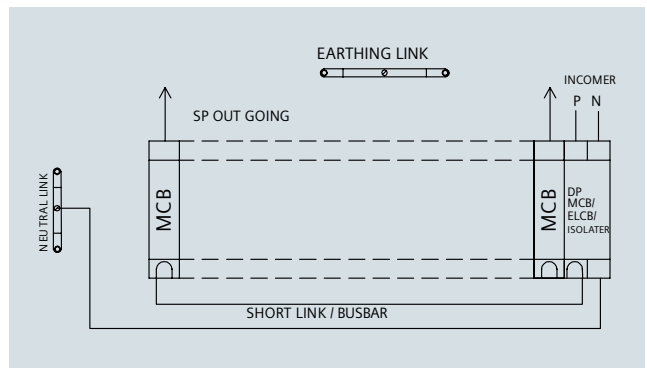

- The wiring diagram inside the door helps during Assembly, Modifications and maintenance of the DB.



- An unique detachable IP Cover facilitates easy maintenance without dismantling an assembled DB and thus results in low downtime.

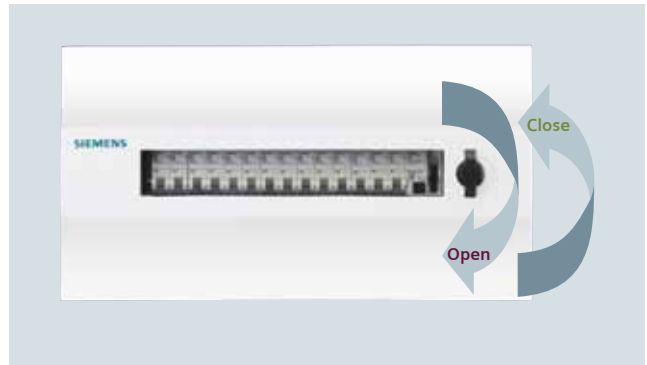

- For total ease of operation and protection the door is secured to the housing by means of a Quarter turn Knob.

### Construction:

To blend style, flexibility and safety, the Betagard distribution boards are manufactured with high precision extra thick, fine quality CRCA steel sheet for long lasting strength.

The Distribution Boards have been treated with premier quality powder coating using latest techniques. The enclosures are subjected to the seven tank process to ensure smooth finish and protection against corrosive atmosphere.









### Certifications:

The Betagard SPN and TPN Distribution Boards are designed to sustain harsh electrical and mechanical conditions. DBs are type tested at internal and external third party laboratories as per IEC 61439 – 1/2 for conditional Short Circuit, Ingress Protection (IP 20 and IP 43), Impact Resistance (IK) and various other parameters. Equipment with a depth of 55 to 70 mm conforming to DIN rails (35mm X 7.5mm) conforming to DIN EN 50022 can be installed in the DBs.

# Betagard Distributions Boards





## Betagard 8GB32 SPN & TPN DBs

### Selection and Ordering Data:

	Item Description	Incoming Slots	Outgoing Slots	Total Slots	Reference No	Std Pkg Nos
<b>Plastic Enclosure, IP20:</b>						
	1/2 Way	–	–	2	8GB0002	1/100
	3/4 Way	–	–	4	8GB0004	1/50
	6 Way	–	–	6	8GB0006	1/25
<b>Retail Segment Single Door DBs, IP20:</b>						
	1 Module	–	–	1	8GB32100RC01	1/50
	2 Module	–	–	2	8GB32100RC02	1/50
	3 Module	–	–	3	8GB32100RC03	1/50
	4 Module	–	–	4	8GB32100RC04	1/50
	6 Module	–	–	6	8GB32100RC06	1/50
	8 Module	–	–	8	8GB32100RC08	1/10
<b>SPN Single Door DBs, IP20:</b>						
	6 Module	2	4	6	8GB32101RC06	1/5
	8 Module	2	6	8	8GB32101RC08	1/5
	10 Module	2	8	10	8GB32101RC10	1/5
	12 Module	2	10	12	8GB32101RC12	1/5
	14 Module	2	12	14	8GB32101RC14	1/5
	16 Module	2	14	16	8GB32101RC16	1/5
<b>SPN Metal Double Door DBs, IP 43:</b>						
	6 Module	2	4	6	8GB32102RC06	1/20
	8 Module	2	6	8	8GB32102RC08	1/15
	10 Module	2	8	10	8GB32102RC10	1/15
	12 Module	2	10	12	8GB32102RC12	1/15
	14 Module	2	12	14	8GB32102RC14	1/10
	16 Module	2	14	16	8GB32102RC16	1/10
<b>SPN Acrylic Double Door DBs, IP 43:</b>						
	6 Module	2	4	6	8GB32103RC06	1/20
	8 Module	2	6	8	8GB32103RC08	1/15
	10 Module	2	8	10	8GB32103RC10	1/15
	12 Module	2	10	12	8GB32103RC12	1/15
	14 Module	2	12	14	8GB32103RC14	1/10
	16 Module	2	14	16	8GB32103RC16	1/10
<b>Wire Way Box For SPN Single Door IP 20 DBs:</b>						
	For 6 MOD SPN Single door DB	–	–	–	8GB32106RC06	1/5
	For 8 MOD SPN Single door DB	–	–	–	8GB32106RC08	1/5
	For 10 MOD SPN Single door DB	–	–	–	8GB32106RC10	1/5
	For 12 MOD SPN Single door DB	–	–	–	8GB32106RC12	1/5
	For 14 MOD SPN Single door DB	–	–	–	8GB32106RC14	1/5
	For 16 MOD SPN Single door DB	–	–	–	8GB32106RC16	1/5
<b>Wire Way Box For SPN Double Door IP 43 DBs:</b>						
	For 6 MOD SPN Single door DB	–	–	–	8GB32107RC06	1/5
	For 8 MOD SPN Single door DB	–	–	–	8GB32107RC08	1/5
	For 10 MOD SPN Single door DB	–	–	–	8GB32107RC10	1/5
	For 12 MOD SPN Single door DB	–	–	–	8GB32107RC12	1/5
	For 14 MOD SPN Single door DB	–	–	–	8GB32107RC14	1/5
	For 16 MOD SPN Single door DB	–	–	–	8GB32107RC16	1/5
<b>Single Door TPN DBs, IP20:</b>						
	4 way	8	12	20	8GB32201RC04	1/5
	6 way	8	18	26	8GB32201RC06	1/5
	8 way	8	24	32	8GB32201RC08	1/5
	10 way	8	30	38	8GB32201RC10	1/5
	12 way	8	36	44	8GB32201RC12	1/5
	14 way	8	42	50	8GB32201RC14	1/5
	16 way	8	48	56	8GB32201RC16	1/5



### Selection and Ordering Data:

	Item Description	Incoming Slots	Outgoing Slots	Total Slots	Reference No	Std Pkg Nos
<b>Metal Double Door TPN DBs, IP 43</b>						
	4 way	8	12	20	8GB32202RC04	1
	6 way	8	18	26	8GB32202RC06	1
	8 way	8	24	32	8GB32202RC08	1
	10 way	8	30	38	8GB32202RC10	1
	12 way	8	36	44	8GB32202RC12	1
	14 way	8	42	50	8GB32202RC14	1
	16 way	8	48	56	8GB32202RC16	1
<b>Acrylic Double Door TPN DBs, IP 43</b>						
	4 way	8	12	20	8GB32203RC04	1
	6 way	8	18	26	8GB32203RC06	1
	8 way	8	24	32	8GB32203RC08	1
	10 way	8	30	38	8GB32203RC10	1
	12 way	8	36	44	8GB32203RC12	1
	14 way	8	42	50	8GB32203RC14	1
	16 way	8	48	56	8GB32203RC16	1
<b>TPN to PPI Conversion Kit</b>						
	To convert 6 way TPN DB to 4 way TPN PPI DB				8GB32205RC04	1
	To convert 8 way TPN DB to 6 way TPN PPI DB				8GB32205RC06	1
	To convert 10 way TPN DB to 8 way TPN PPI DB				8GB32205RC08	1
	To convert 12 way TPN DB to 10 way TPN PPI DB				8GB32205RC10	1
	To convert 14 way TPN DB to 12 way TPN PPI DB				8GB32205RC12	1
	To convert 16 way TPN DB to 14 way TPN PPI DB				8GB32205RC14	1
<b>Wire Way Box For TPN Single Door IP 20 DBs</b>						
	For 4 Way TPN Single door DB	-	-	-	8GB32206RC04	1/5
	For 6 Way TPN Single door DB	-	-	-	8GB32206RC06	1/5
	For 8 Way TPN Single door DB	-	-	-	8GB32206RC08	1/5
	For 10 Way TPN Single door DB	-	-	-	8GB32206RC10	1/5
	For 12 Way TPN Single door DB	-	-	-	8GB32206RC12	1/5
	For 14 Way TPN Single door DB	-	-	-	8GB32206RC14	1/5
	For 16 Way TPN Single door DB	-	-	-	8GB32206RC16	1/5
<b>Wire Way Box For TPN Double Door IP 43 DBs</b>						
	For 4 Way TPN Single door DB	-	-	-	8GB32207RC04	1/5
	For 6 Way TPN Single door DB	-	-	-	8GB32207RC06	1/5
	For 8 Way TPN Single door DB	-	-	-	8GB32207RC08	1/5
	For 10 Way TPN Single door DB	-	-	-	8GB32207RC10	1/5
	For 12 Way TPN Single door DB	-	-	-	8GB32207RC12	1/5
	For 14 Way TPN Single door DB	-	-	-	8GB32207RC14	1/5
	For 16 Way TPN Single door DB	-	-	-	8GB32207RC16	1/5
<b>Double Door, Phase Segregated TPN DBs (7 segment), IP42:</b>						
	4 Way	12	12+12	36	8GB0504	1
	6 Way	12	12+18	42	8GB0506	1
	8 Way	12	12+24	48	8GB0508	1
	12 Way	12	12+36	60	8GB0512	1

# Betagard Distributions Boards

## Betagard 8GB32 SPN & TPN DBs

### Dimensional drawings:

#### Plastic Enclosure (8GB000)

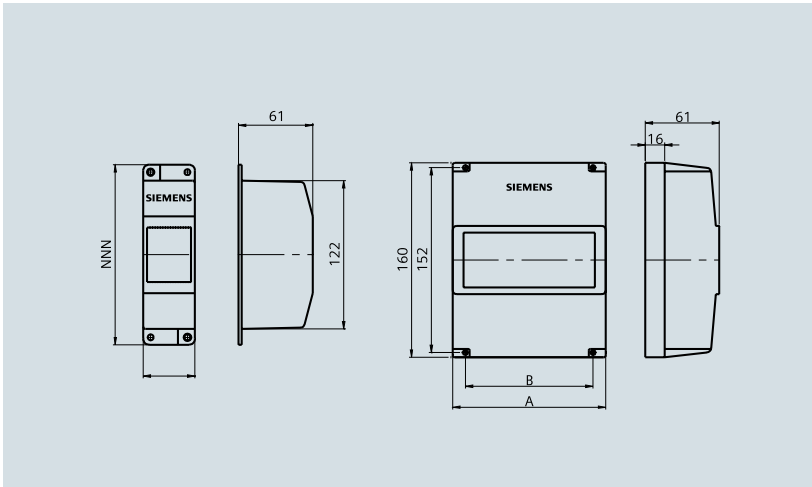

Model	A	B
8GB0002	40	30
8GB0004	90	80
8GB0006	126	105

#### Retail Segment Metal Enclosures

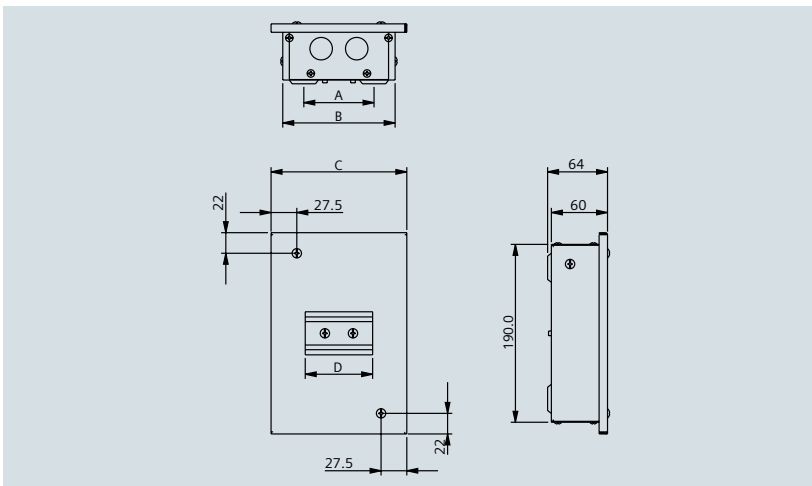

**Note:**

- 1) Powder Coating 80±20µ
- 2) Colour Ivory White RAL 9016
- 3) All dimensions are in mm

Model	A	B	C	D	Knockouts Per Side (Top & Bottom) Ø 26
8GB32100RC01	35	80	105	18	1
8GB32100RC02	60	105	130	36	2
8GB32100RC03				54	
8GB32100RC04	75	120	145	72	2
8GB32100RC06	145	190	215	108	4
8GB32100RC08				144	

### Dimensional drawings:

#### SPN Single Door DBs

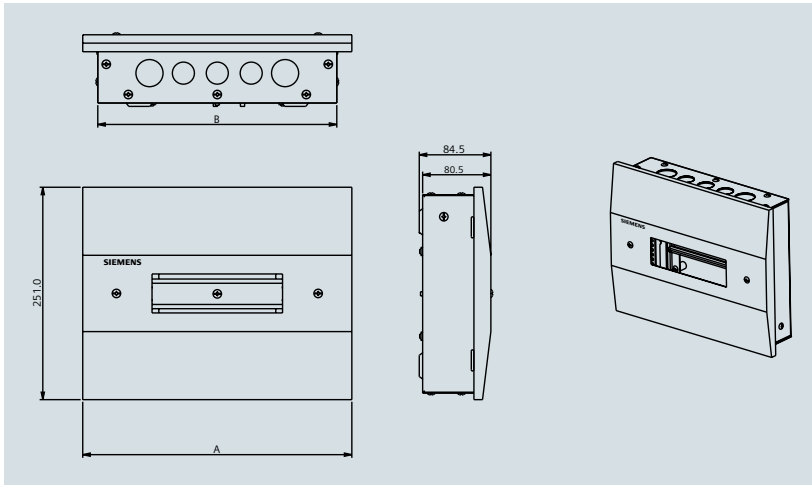

Note:

- 1) Powder coating  $80\pm 20\mu$
- 2) Colour ivory white RAL-9016 shade
- 3) All dimensions are in mm.

Model	A	B	Knockouts Per Side (Top & Bottom)	
			Ø 26	Ø 32
8GB32101RC06	317.5	282	3	2
8GB32101RC08				
8GB32101RC10	389.5	354	4	2
8GB32101RC12				
8GB32101RC14	461.5	426	5	2
8GB32101RC16				

#### SPN Metal Double Door DBs

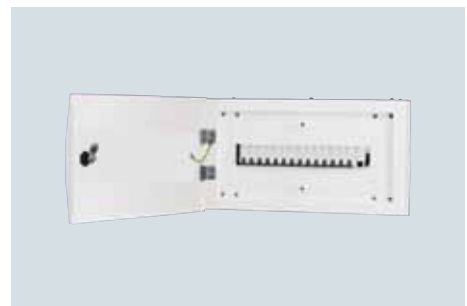
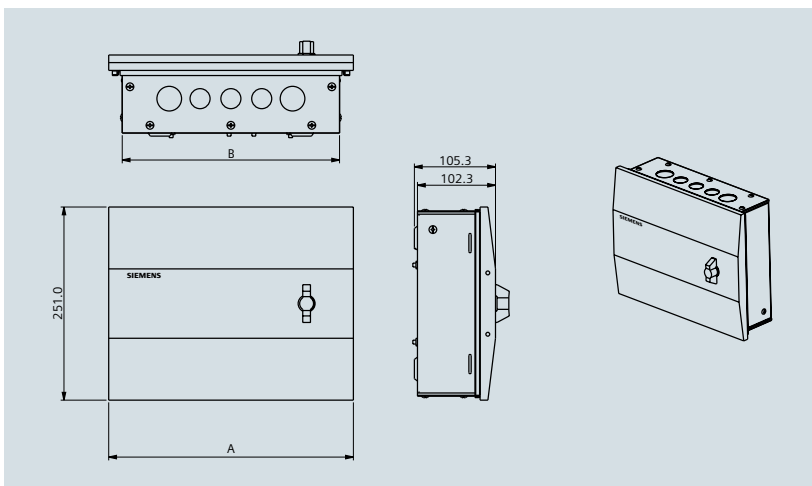

Note:

- 1) Powder coating  $80\pm 20\mu$
- 2) Colour ivory white RAL-9016 shade
- 3) All dimensions are in mm.

Model	A	B	Knockouts Per Side (Top & Bottom)	
			Ø 26	Ø 32
8GB32102RC06	317.5	282	3	2
8GB32102RC08				
8GB32102RC10	389.5	354	4	2
8GB32102RC12				
8GB32102RC14	461.5	426	5	2
8GB32102RC16				

# Betagard Distributions Boards

## Betagard 8GB32 SPN & TPN DBs

### Dimensional drawings:

#### SPN Acrylic Double Door DBs

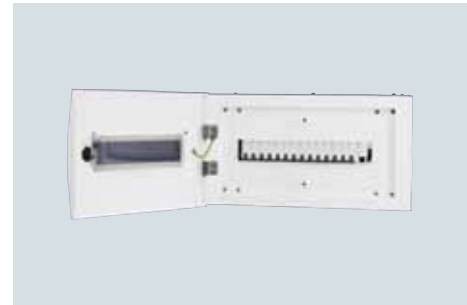
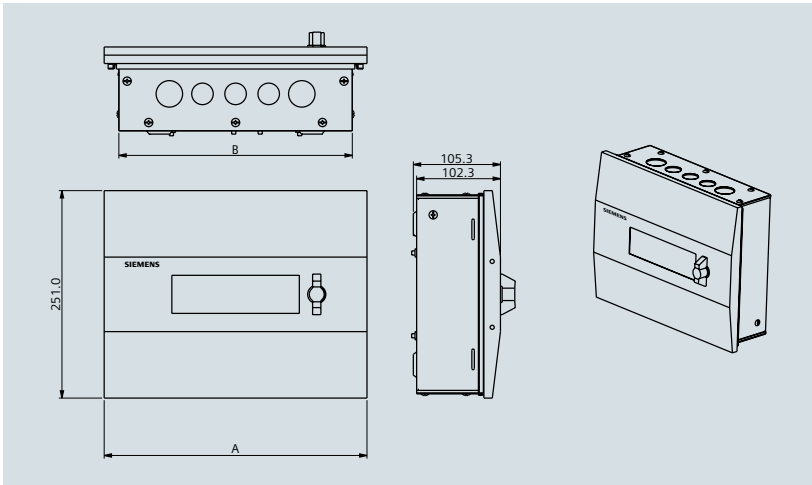

Note:

- 1) Powder coating  $80\pm 20\mu$
- 2) Colour ivory white RAL-9016 shade
- 3) All dimensions are in mm.

Model	A	B	Knockouts Per Side (Top & Bottom)	
			Ø 26	Ø 32
8GB32103RC06	317.5	282	3	2
8GB32103RC08				
8GB32103RC10	389.5	354	4	2
8GB32103RC12				
8GB32103RC14	461.5	426	5	2
8GB32103RC16				

#### PAN assembly complete - SPN MCB DB

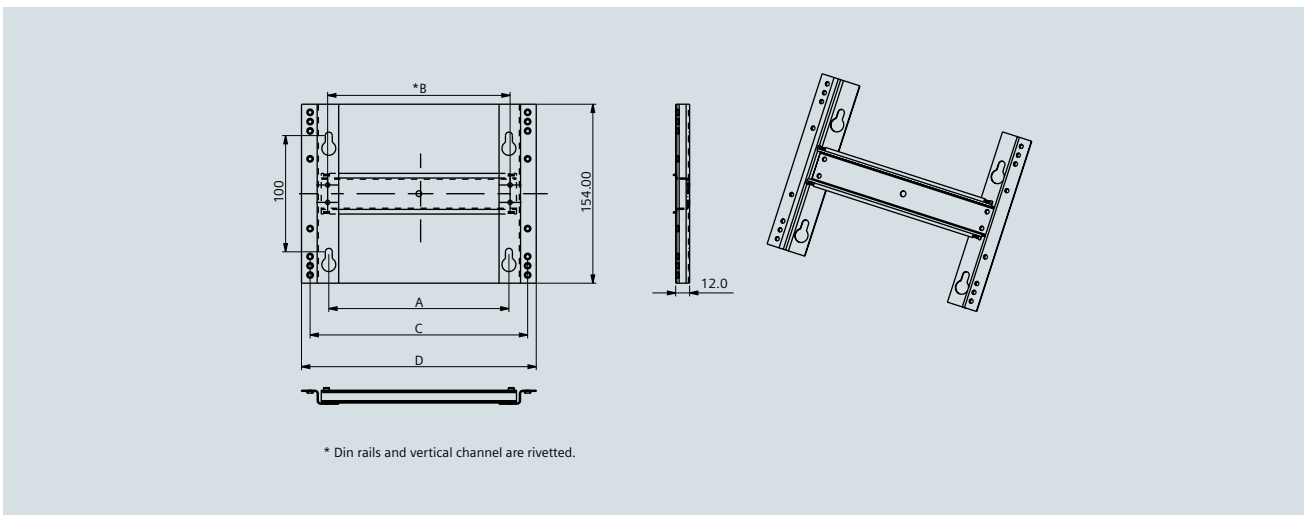

Model	A	B	C	D
8GB321-01/02/03-RC06	155	157	187.2	202
8GB321-01/02/03-RC08				
8GB321-01/02/03-RC10	227	229	259.2	274
8GB321-01/02/03-RC12				
8GB321-01/02/03-RC14	299	301	331.2	346
8GB321-01/02/03-RC16				

### Dimensional drawings:

#### Wire Way Boxes for SPN Single Door and Double Door DBs

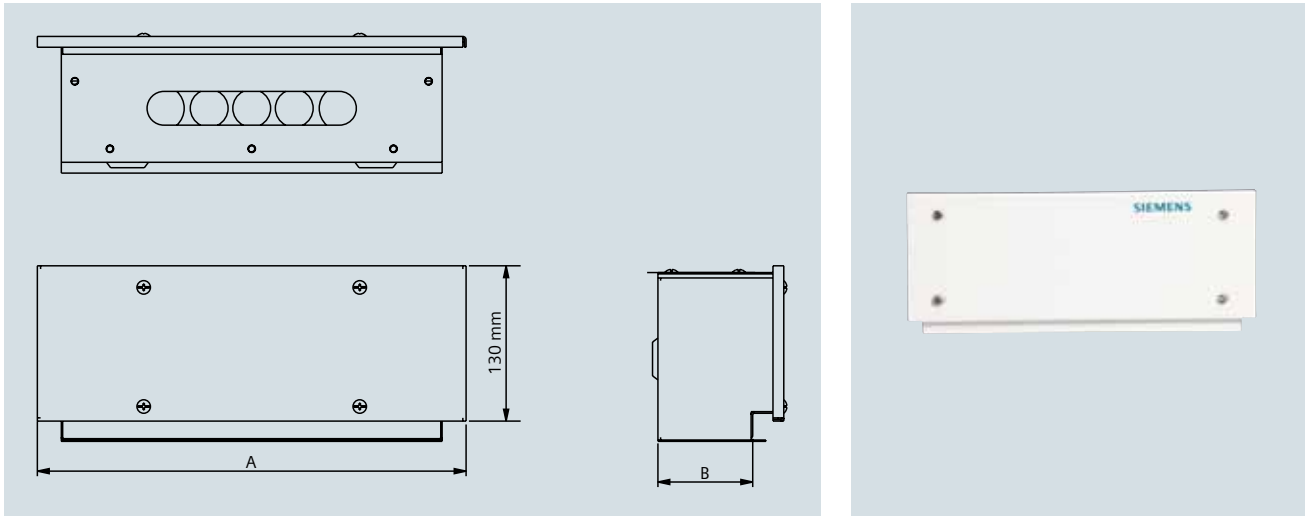

Model	A	B	Knock outs On the Gland Plate	
			Ø 26	Ø 32
8GB32106RC06	317.5	55	3	2
8GB32106RC08				
8GB32106RC10				
8GB32106RC12	389.5		4	2
8GB32106RC14	461.5		5	2
8GB32106RC16				
8GB32107RC06	317.5	70.2	3	2
8GB32107RC08				
8GB32107RC10	389.5		4	2
8GB32107RC12				
8GB32107RC14			461.5	5
8GB32107RC16				

# Betagard Distributions Boards

## Betagard 8GB32 SPN & TPN DBs

### Dimensional drawings:

#### Single Door TPN DBs

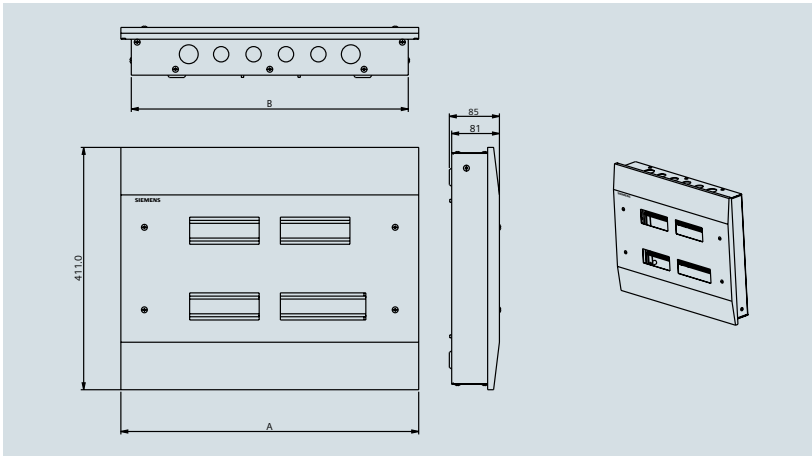

Note:

- 1) Powder coating  $80\pm 20\mu$
- 2) Colour ivory white RAL-9016 shade
- 3) All dimensions are in mm.

Model	A	D	Knock out Per side (Top & Bottom)	
			Ø 26	Ø 32
8GB32201RC04	506	470	5	2
8GB32201RC06				
8GB32201RC08				
8GB32201RC10	604.4	569	6	2
8GB32201RC012				
8GB32201RC14				
8GB32201RC16	748.4	713	8	2
	811.4	776	8	2

#### Metal Double Door TPN DBs

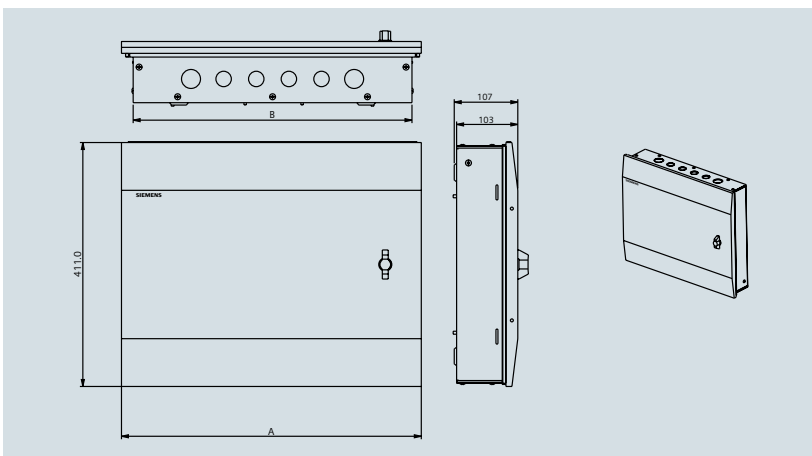

Note:

- 1) Powder coating  $80\pm 20\mu$
- 2) Colour ivory white RAL-9016 shade
- 3) All dimensions are in mm.

ML FB	A	B	Knockouts Per Side (Top & Bottom)	
			Ø 26	Ø 32
8GB32202RC04	506	470	5	2
8GB32202RC06				
8GB32202RC08				
8GB32202RC10	604.4	569	6	2
8GB32202RC12				
8GB32202RC14				
8GB32202RC16	748.4	713	8	2
	811.4	776	8	2

### Dimensional drawings:

#### Acrylic Double Door TPN DBs

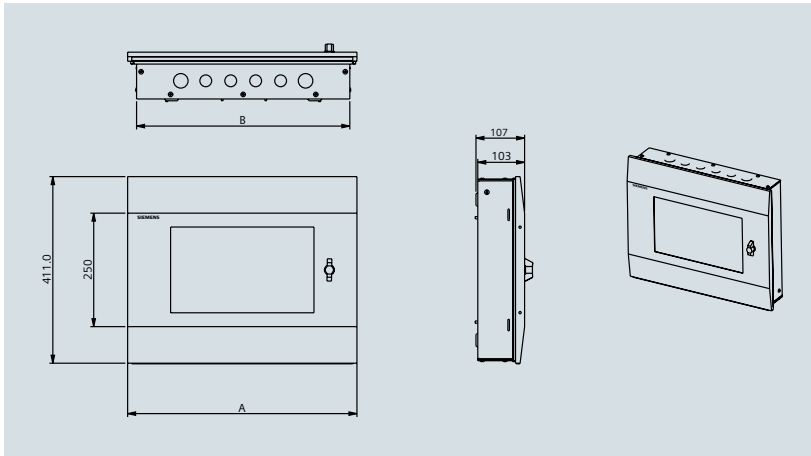

Note:

- 1) Powder coating  $80 \pm 20 \mu$
- 2) Colour ivory white RAL-9016 shade
- 3) All dimensions are in mm.

Model	A	B	Knockouts Per Side (Top & Bottom)	
			Ø 26	Ø 32
8GB32203RC04	506	470	5	2
8GB32203RC06				
8GB32203RC08				
8GB32203RC10	604.4	569	6	2
8GB32203RC12				
8GB32203RC14	748.4	713	8	2
8GB32203RC16				
8GB32203RC16	811.4	776	8	2

#### PAN assembly - TPN MCB DB

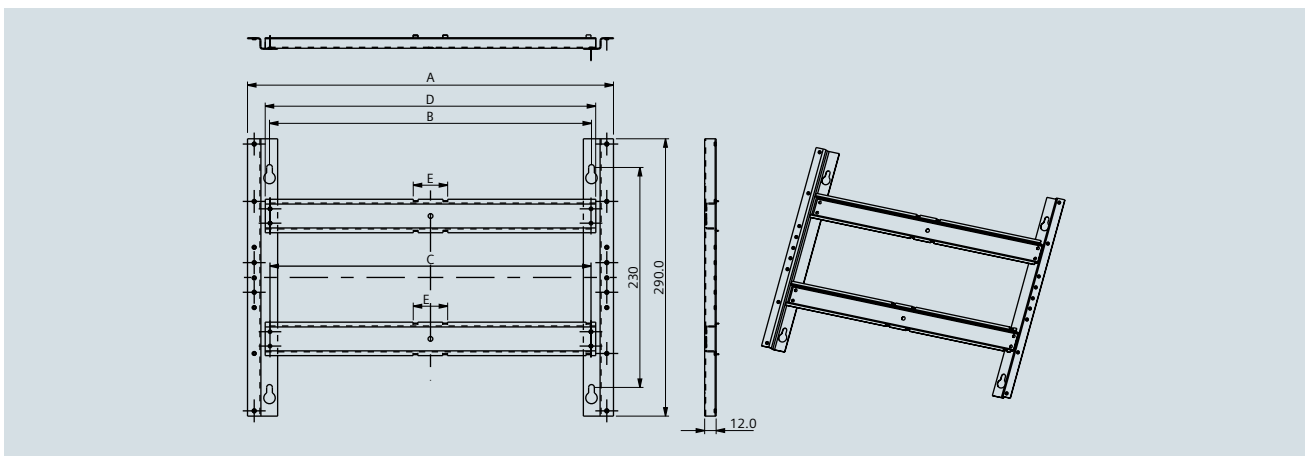

MLFB	Type	A	B	C	D	E
8GB322-01/02/03-RC04	4 Way	380.7	336.7	335.6	345.6	36
8GB322-01/02/03-RC06	6 Way					
8GB322-01/02/03-RC08	8 Way					
8GB322-01/02/03-RC10	10 Way	479.7	435.7	434.6	444.6	45
8GB322-01/02/03-RC12	12 Way					
8GB322-01/02/03-RC14	14 Way	623.7	579.7	578.6	588.6	45
8GB322-01/02/03-RC16	16 Way					
8GB322-01/02/03-RC16	16 Way	686.7	642.7	641.6	651.6	36

Note:

- 1) Plating: FeZn 10 Micron, Blue Passivation

# Betagard Distributions Boards

## Betagard 8GB32 SPN & TPN DBs

### Dimensional drawings:

#### DD Phase Segregated 7 Segment TPN DB (8GB05)

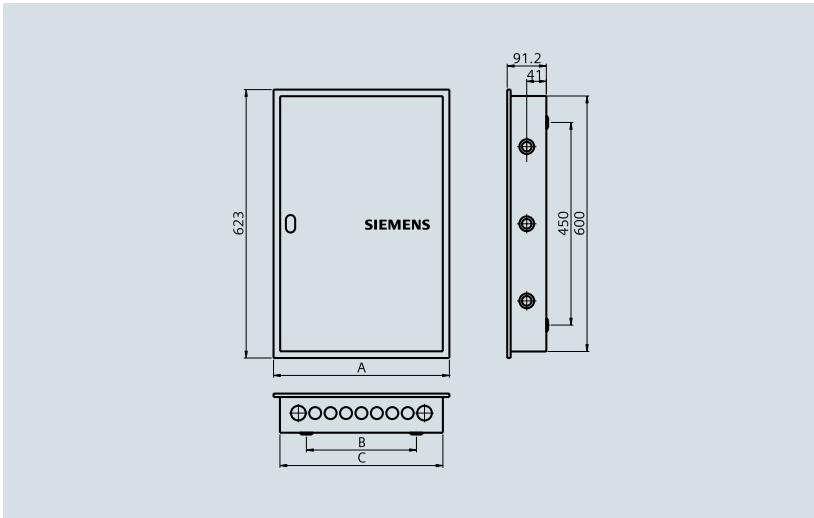

Model	A	B	C	Knock out		
				Per side (Top & Bottom)		Per side flap Ø32 & Ø21
				Ø32	Ø40	
8GB0504	451	324	424	-	6	3
8GB0506	559	432	532	-	6	3
8GB0508	667	540	640	-	6	3
8GB0512	883	756	856	-	6	3



### Dimensional drawings:

#### Wire Way Boxes for TPN Single Door and Double Door DBs

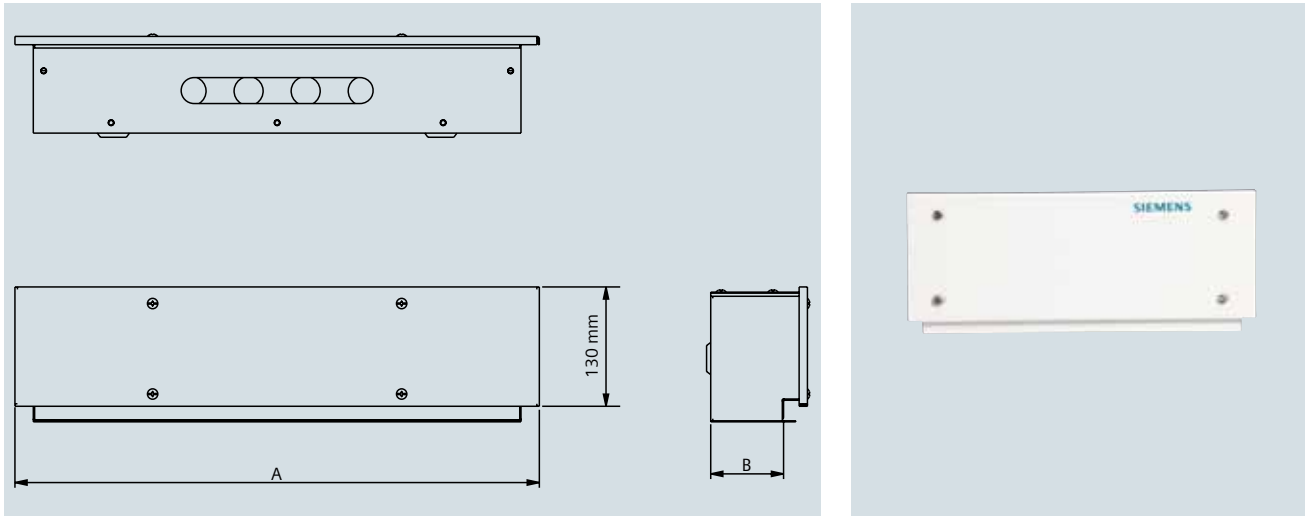

Model	A	B	Knock outs On the Gland Plate	
			Ø 26	Ø 32
8GB32206RC04	505.4	55	5	2
8GB32206RC06				
8GB32206RC08	604.4	55	6	2
8GB32206RC10				
8GB32206RC12	748.4	55	8	2
8GB32206RC14				
8GB32206RC16	811.4	55	8	2
8GB32207RC04	505.4	70.2	5	2
8GB32207RC06				
8GB32207RC08	604.4	70.2	6	2
8GB32207RC10				
8GB32207RC12	748.4	70.2	8	2
8GB32207RC14				
8GB32207RC16	811.4	70.2	8	2

# Betagard Distributions Boards

## Betagard 8GB32 SPN & TPN DBs

### Wiring Diagram:

#### SPN DB

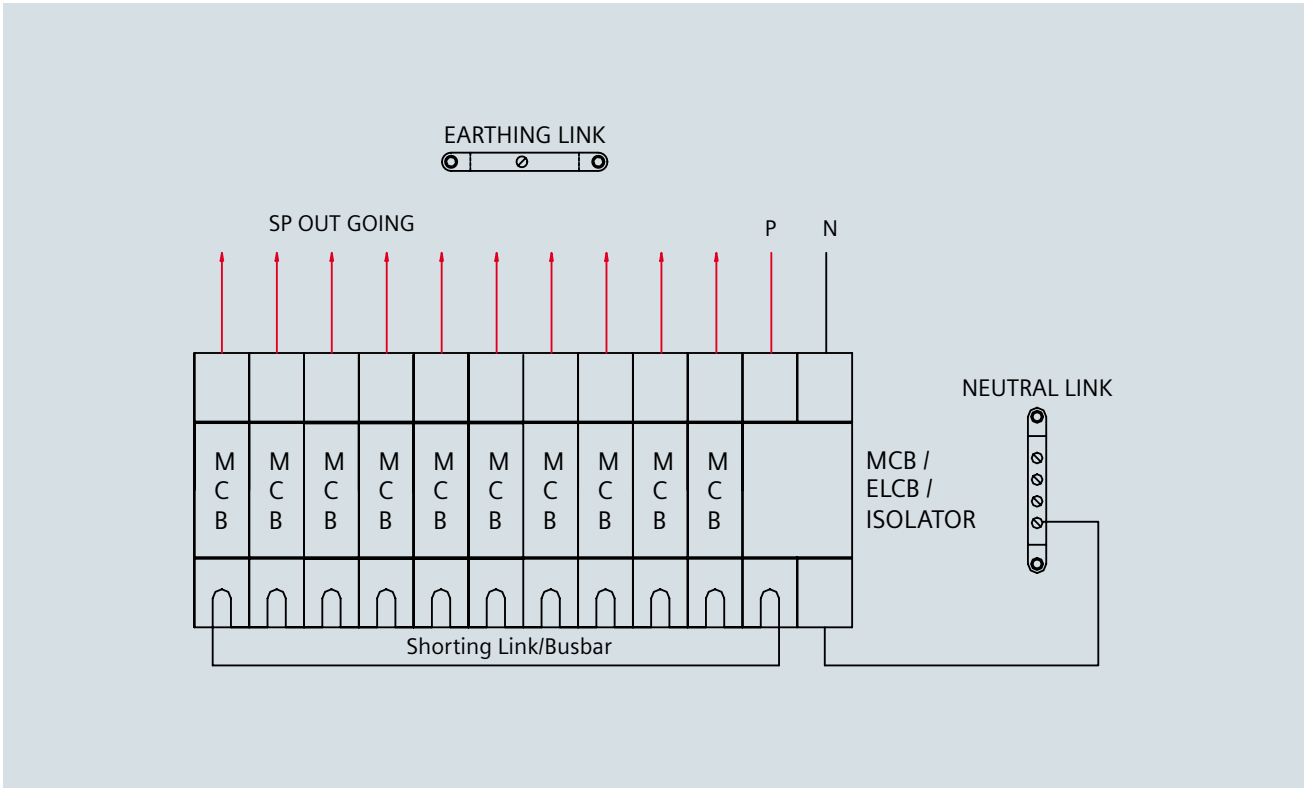

#### TPN DB

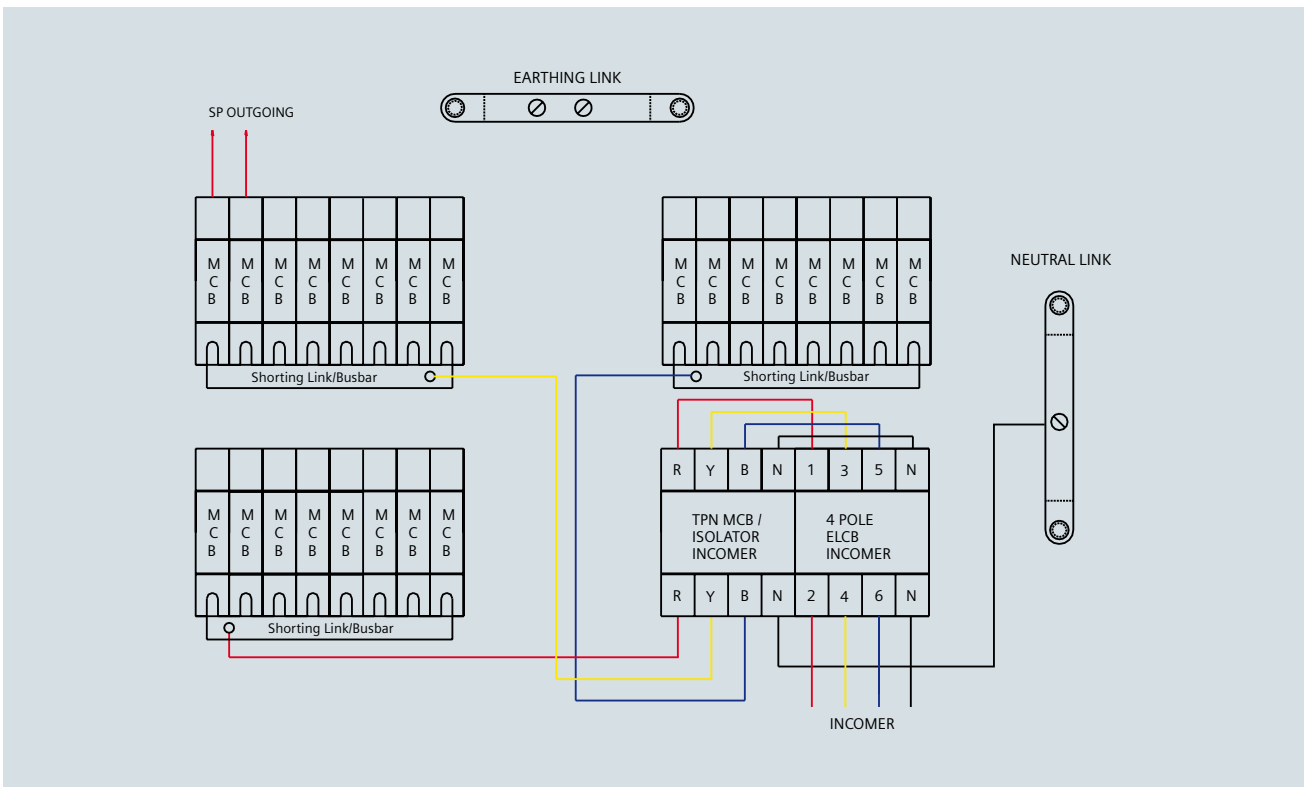

### Wiring Diagram:

#### TPN Phase Segregated

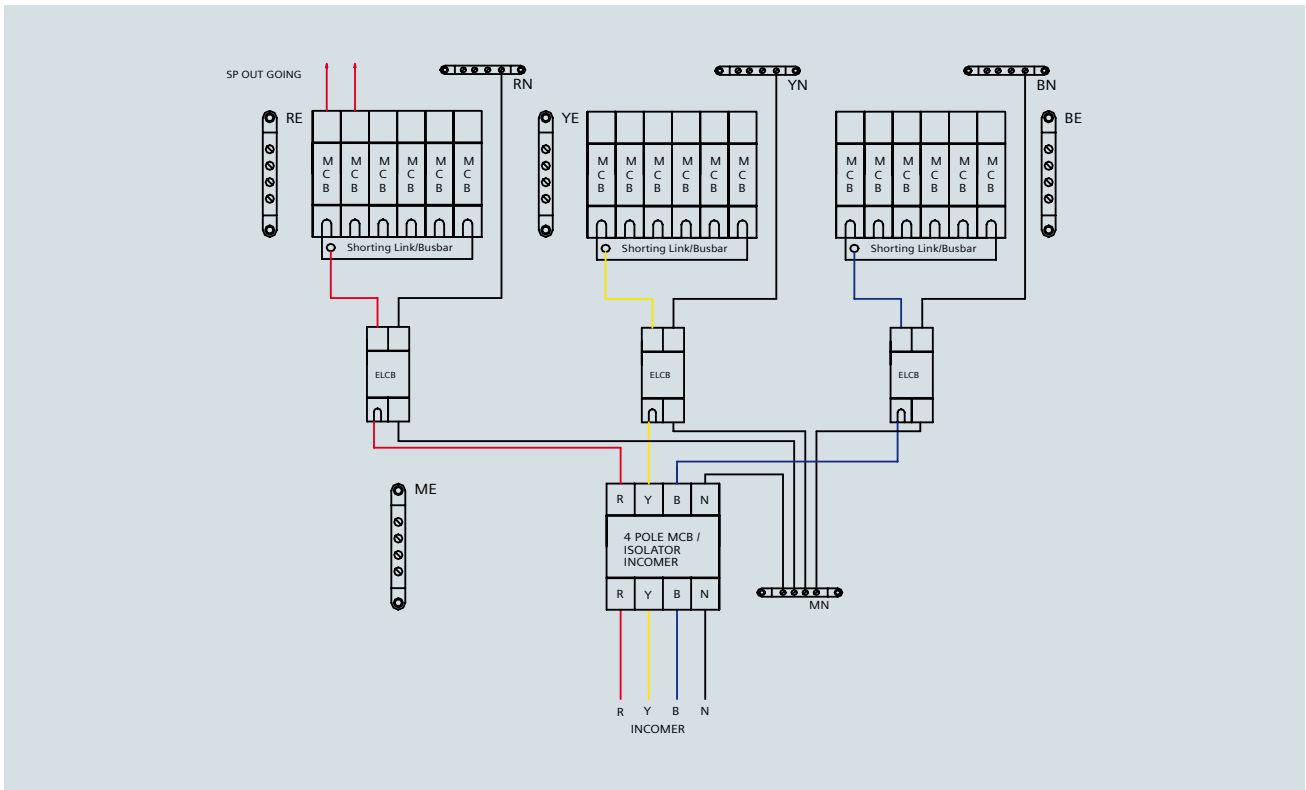

#### TPN PPI DB

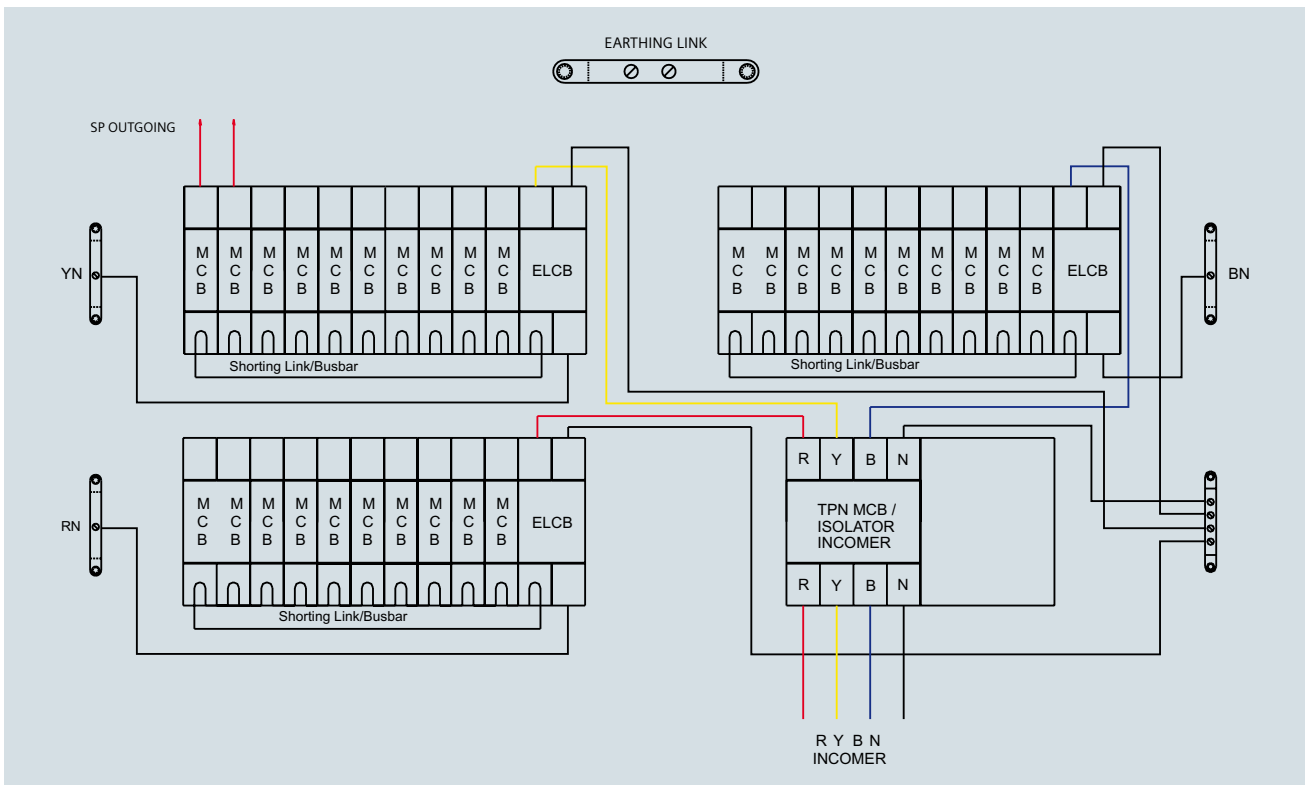

# Betagard Distributions Boards

## Betagard 4in1 Appliance Protector and Industrial Plug and Socket DBs

### Concept:

1. Shock proof ABS enclosure
2. 3pin Delta vega socket with safety shutter
3. Over load and short circuit protection for connected equipment and cables
4. Power ON indication to indicate status of equipment

### Design and construction:

Electrical equipment makes an important contribution to the amenities in terms of aesthetic look, apart from protecting electrical equipments. In certain cases, the effect of these amenities is perceived directly. e.g.: matching decor with elegant Air conditioner

In residence. Siemens Betagard 4 in 1 protective device is made in completely ABS material which is non-corrosive and shock proof.

The flush design of 4 in 1 comes with sheet steel base (which goes in side the wall) and thermoplastic aesthetic front cover with SP/DP MCB with socket.

### Installation:

Betagard 4 in 1 protective device is available in flush as well as surface mounting versions.

All versions of 4 in 1 are supplied with factory fitted and calibrated MCB and pre wired which eventually in ready to use condition. However depending on the application the rating of MCBs has to be selected. The recommendations are given below for selecting the right MCB for right appliances.

Appliance	Capacity (Watts)	MCB current ratings (Amps)	
Iron	1200	6	
Mixer/Juicer	200	2	
Microwave oven	750	6	
Hot plate	2000	10	
Electrical kettle	1500	10	
T.V./VCR/Audio system	200	2	
Refrigerator 165 liters	400	2	
Refrigerator 350 liters	750	4	
Geyser	1000	10	
	2000	16	
	3000	20	
Air conditioners	1 ton	1500	10
	1.5 ton	2500	16
	2.5 ton	3500	20

Due to elegant look and compact design these products are highly recommended for following home appliances.

1. Air conditioners
2. Geysers
3. Kitchen equipment like refrigerators, micro ovens, water filters
4. Washing machine

Apart from residential equipment protection these devices are also can safely used to protect following expensive equipments in commercial segment.

1. Hospital equipment
2. Studio equipment
3. Commercial shops
4. Multiplexes and shopping malls

### Unique features:





1. Socket life of 4in1 is enhanced since the making / breaking of circuit is done by MCB which has a built-in arc quenching mechanism.
2. Total safety due to thermo plastic design and ideal for installations in bathrooms, kitchen and club houses etc.
3. The aesthetic ivory white ABS enclosure matches all kind of decor.



# Betagard Distributions Boards

## Betagard 4in1 Appliance Protector and Industrial Plug and Socket DBs

### Selection and Ordering Data:

	Item Description	Total Slots	Reference No	Std Pkg Nos
<b>Plug &amp; Socket, IP20 with provision for MCB mounting :</b>				
 	1 Phase 20A, 1P MCB	1	■ 8GB0501RC	1/20
	1 Phase 20A, 2P MCB	2	■ 8GB0501SRC	1/20
	3 Phase 32A, 3P MCB	3	■ 8GB0502	1/15
	3 Phase 32A, 3P+N MCB	4	8GB0502S	1/15
	5 Pin (3P+N+PE) 3 Phase 32A MCB 3P+N MCB	8	■ 8GB050332	1/15
	5 Pin (3P+N+PE) 3 Phase 63A MCB 3P+N MCB	8	8GB050363	1/5
<b>4 in 1 Appliance Protector Pre Wired, IP 20 with factory fitted Betagard 5SL MCB :</b>				
				
<b>Flush Mounting</b>				
	4in1, FM with 16A,1P MCB and 10/16A socket	1	8GB11611RC	1/20
	4in1, FM with 16A,2P MCB and 10/16A socket	2	8GB11612RC	1/20
	4in1, FM with 25A,1P MCB and 25A socket	1	8GB11621RC	1/20
	4in1, FM with 25A,2P MCB and 25A socket	2	8GB11622RC	1/20
<b>Surface Mounting</b>				
	4in1, SM with 6A, 1P MCB and 6A socket	1	8GB13601RC	1/20
	4in1, SM with 6A, 2P MCB and 6A socket	2	8GB13602RC	1/20
	4in1, SM with 16A,1P MCB and 10/16A socket	1	8GB13611RC	1/20
	4in1, SM with 16A,2P MCB and 10/16A socket	2	8GB13612RC	1/20
	4in1, SM with 25A,1P MCB and 25A socket	1	8GB13621RC	1/20
	4in1, SM with 25A,2P MCB and 25A socket	2	8GB13622RC	1/20



# Betagard Distributions Boards

## Betagard 4in1 Appliance Protector and Industrial Plug and Socket DBs

### Dimensional drawings:

#### Single Phase Plug and Socket (8GB0501)

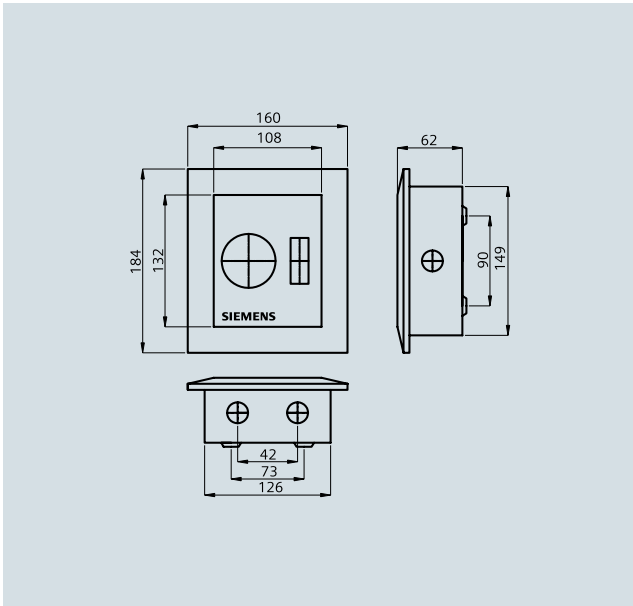

Model	Cutout Width
8GB0501RC	18
8GB0501SRC	36

Note:

\* 2 Pin Plug

2 Knock outs of Ø21 on Top & Bottom

1 Knock out of Ø21 on per Side flap

#### Three Phase Plug and Socket (8GB0502)

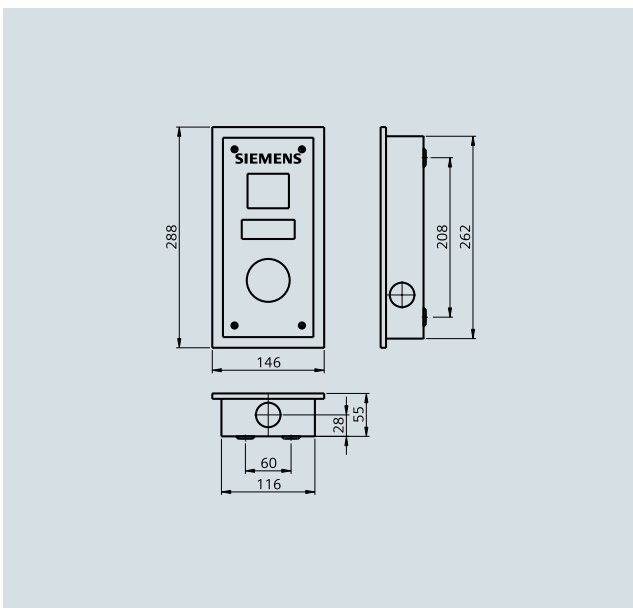

Model	Cutout Width
8GB0502RC	54
8GB0502SRC	72

Note:

\* 3 Pin Plug

1 Knock outs of Ø32 on Top & Bottom

1 Knock out of Ø32 on per Side flap

### Dimensional drawings:

#### 5 Pin Three Phase+N+PE Industrial Plug and Socket (8GB0503)

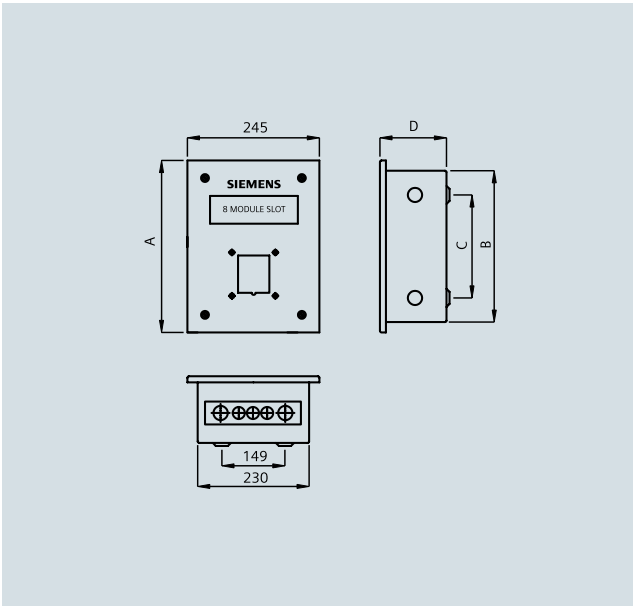

Model	A	B	C	D
8GB050332	265	247	182	91.5
8GB050363	290	272	207	121.5

#### Betagard 4 in 1 Protector Device

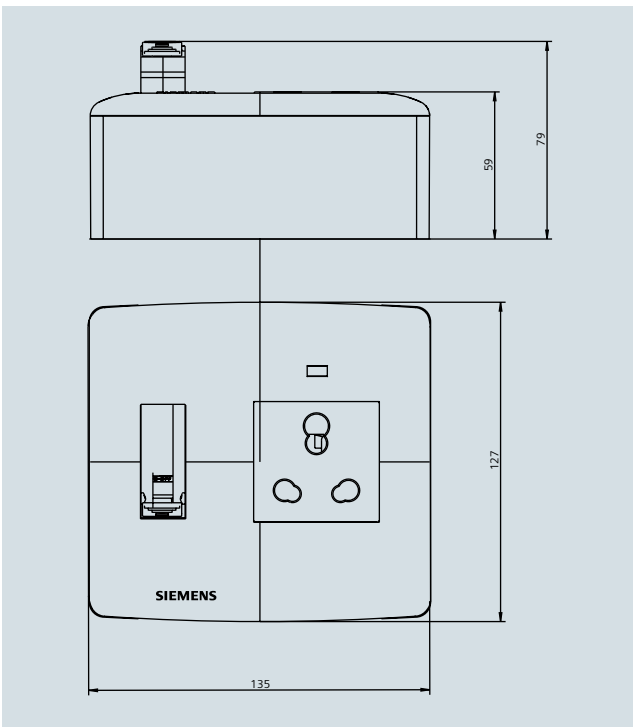

Surface mounting

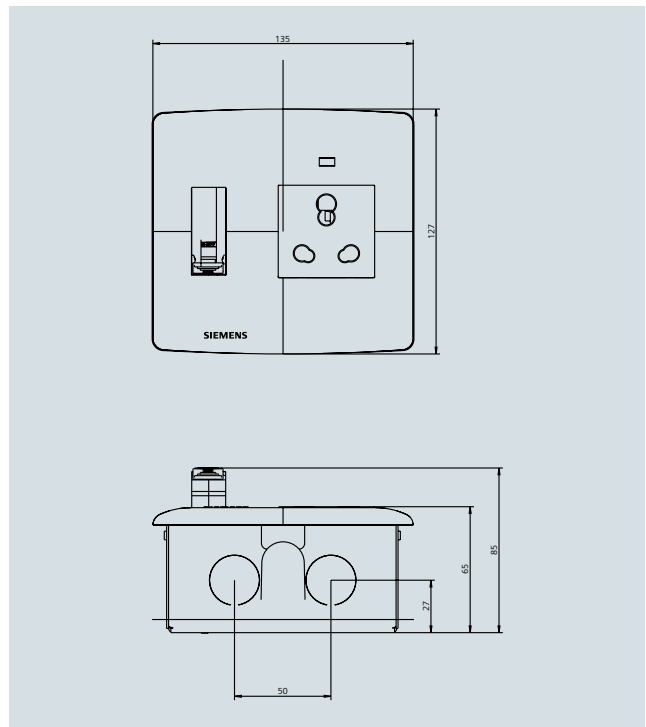

Flush / Concealed mounting

# Betagard Distributions Boards

## Betagard 8GB31 DBs

Betagard MB distribution boards have been made from special EDD (extra deep drawing) quality steel for better strength. The attractive convex shape design has been achieved by innovative deep drawn technology.

A unique top hung flap type door design shall facilitate easy removal of door for accessing the components. A 15 deg correction factor is possible at the concealed U-box of distribution boards if the same is not installed properly.

- Detachable din rail for neat and hassle-free wiring
- Insulated N and PE links ensures safe installation complaint Hardware
- Deep drawn design, the overall strength of DB has been enhanced & possibility of transit damage has been totally eliminated
- The detachable door can be installed after completion of the project which helps in retaining the aesthetics of the DB

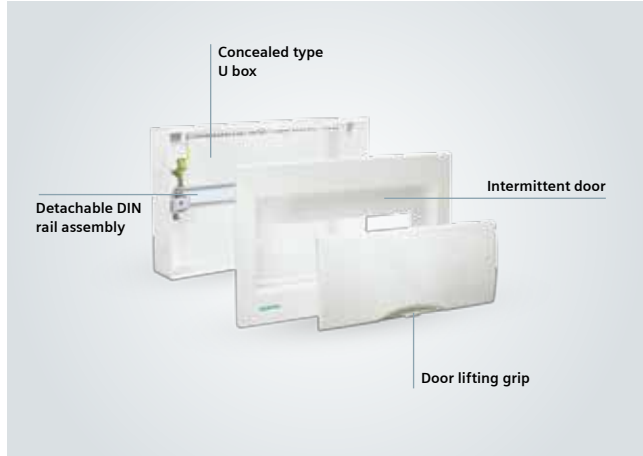



Beta distribution boards are suitable as sub distribution boards in all commercial and industrial applications. Owing to their small overall depth, they can be used in both commercial and industrial complexes and are usually installed in the vicinity of respective load centers.

Beta distribution boards are connected down stream of the meter cabinet and the main or storey distribution board.

Equipment with a depth of 55 to 70 mm conforming to DIN rails (35mm X 7.5mm) conforming to DIN EN 50022 can be installed in the units.

In order to cater to various complex configurations in modern electric installation, we are glad to introduce following 5 new generations DBs. Flush as well as surface type distribution boards are available from 4 ways to 12 ways in double door version.

Beta DBs range offers only double door version with IP 42 protection.

- **Beta Flex DBs** are offered in row system and are available in 12 & 16 Mod/Row designs. Presently these DBs are being offered in 2 Rows & 4 Rows configuration.
- **Beta Bus DBs** are designed with vertical readymade insulated bus bar and are available with 4W/6W/8W and 12WAY TP/SP configuration.
- **Beta Bus Plus DBs** are also having special feature of accommodating Siemens 3VT MCCB as I/C up to 160A apart from featured offered in Beta Bus.
- **Beta Multi DBs** are having a special feature of accommodating TV Splitter and Telephone crone connector apart from LV power distribution.
- **Beta change over DBs** are designed to cater to few specific requirements of regions where-in the consistent availability 3 phase supplies are not reliable.

These DBs have provision of fixing 40/63A change over switch in order to shift the phase in the event of failure of any one phase in 3 phase network.

### Design:

Siemens Betagard distribution boards are manufactured in sheet steel and have been specially designed, keeping in view the interiors of modern day houses and commercial establishments.

### Installation:

Betagard distribution boards are suitable for both in flush as well as surface mounting applications.

These distribution boards are provided with removable top and bottom gland plates with adequate number of knock outs, enabling easy installation and connection of conduits of all sizes for top and bottom entry of cables.

Double door construction of DBs facilitates easy removal of inspection window mounted on intermediate plate.

A 15 deg correction factor is possible if the U plate of distribution boards is wrongly installed.

### Construction:

Blending style, flexibility and safety, the Betagard distribution boards are manufactured with high precision extra thick and fine quality CRCA steel sheet for long lasting strength.

These DBs undergo a seven tank phosphating process to ensure anti rust conditioning and superior finish.

### Double door concept for aesthetic and safety:

To ensure total safety, an intermediate plate has been introduced so that when the door is opened, no live parts are exposed. The door is earthed through a copper braid for total safety.







1. **Removable intermittent window.....** For easy in maintenance / installation
2. **Removable intermittent door.....** Ivory-white in color to match any décor
3. **Magnetic latch.....** For firm door latching and comforts in opening and closing of DB doors
4. **Vertical insulated busbar.....** Total safety and flexibility in mounting TP/SP MCBS







# Betagard Distributions Boards

## Betagard 8GB31 DBs

### Selection and Ordering Data:

	Item Description	Incoming Slots	Outgoing Slots	Total Slots	Reference No	Std Pkg Nos
<b>Betagard MB (Ivory White):</b>						
	1 Row, 6 Mod	2	4	6	8GB31810RC01	1/10
	1 Row, 8 Mod	2	6	8	8GB31811RC01	1/10
	1 Row, 10 Mod	2	8	10	8GB31812RC01	1/10
	1 Row, 12 Mod	2	10	12	8GB31813RC01	1/10
	1 Row, 14 Mod	2	12	14	8GB31814RC01	1/10
	1 Row, 16 Mod	2	14	16	8GB31815RC01	1/10
<b>Betagard MB (Metallic Grey):</b>						
	1 Row, 6 Mod	2	4	6	8GB31810RC02	1/10
	1 Row, 8 Mod	2	6	8	8GB31811RC02	1/10
	1 Row, 10 Mod	2	8	10	8GB31812RC02	1/10
	1 Row, 12 Mod	2	10	12	8GB31813RC02	1/10
	1 Row, 14 Mod	2	12	14	8GB31814RC02	1/10
	1 Row, 16 Mod	2	14	16	8GB31815RC02	1/10
<b>Betagard MB (Metallic Carbon):</b>						
	1 Row, 6 Mod	2	4	6	8GB31810RC03	1/10
	1 Row, 8 Mod	2	6	8	8GB31811RC03	1/10
	1 Row, 10 Mod	2	8	10	8GB31812RC03	1/10
	1 Row, 12 Mod	2	10	12	8GB31813RC03	1/10
	1 Row, 14 Mod	2	12	14	8GB31814RC03	1/10
	1 Row, 16 Mod	2	14	16	8GB31815RC03	1/10
<b>Betaflex (Flexi DBs), IP42:</b>						
	2Row x 12Mod	—	—	24	8GB31424RC	1/5
	2Row x 16Mod	—	—	32	8GB31426RC	1/5
	4Row x 8Mod	—	—	32	8GB31442RC	1/5
	4Row x 12Mod	—	—	48	8GB31444RC	1/5
	4Row x 16Mod	—	—	64	8GB31446RC	1/5
	<b>Betabus (Vertical Busbar DBs with MCB as an incomer), IP42: (Suitable for 5SX/5SJ/5SP MCBs, upto 125A as an incomer)</b>					
	4 way	12	12	24	8GB31471RC	1/5
	6 way	12	18	30	8GB31473RC	1/5
	8 way	12	24	36	8GB31474RC	1/5
	12 way	12	36	48	8GB31477RC	1/5
<b>Betabusplus (Vertical Busbar DBs with MCCB as an incomer), IP42: (Suitable for 3VT1 MCCBs, upto 160A as an incomer)</b>						
	4 way	12	12	24	8GB31571RC	1/5
	6 way	12	18	30	8GB31572RC	1/5
	8 way	12	24	36	8GB31573RC	1/5
	12 way	12	36	48	8GB31574RC	1/5

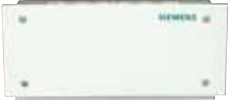
### Selection and Ordering Data:

	Item Description	Incoming Slots	Outgoing Slots	Total Slots	Reference No	Std Pkg Nos
<b>BetaMulti (DBs for power &amp; communication), IP42:</b>						
	12way SPN, provision	2	12	14	8GB31215RC	1/5
	6way TPN, provision	8	18	26	8GB31221RC	1/5
	12way SPN, built-in	2	12	14	8GB31315RC	1/5
	6way TPN, built-in	8	18	26	8GB31321RC	1/5
<b>Beta CO (DBs for phase changeover), IP42:</b>						
	4 Way, With Provision	8	12	20	8GB31840RC	1/5
	6 way, with provision	8	18	26	8GB31841RC	1/5
	8 way, with provision	8	24	32	8GB31842RC	1/5
	12 way, with provision	8	36	44	8GB31844RC	1/5
<b>Wire Way Boxes (WWB)</b>						
	WWB for Flexi DB, 8Mod	—	—	—	8GB9908FWWNT	1/5
	WWB for Flexi DB, 12Mod	—	—	—	8GB9912FWWNT	1/5
	WWB for Flexi DB, 16Mod	—	—	—	8GB9916FWWNT	1/5
	WWB for Bus DB	—	—	—	8GB99BUSWWNT	1/5
	WWB for Bus Plus DB	—	—	—	8GB99PLUSWWNT	1/5
<b>Modular Device Boxes (MDB)</b>						
	MDB for Flexi DB, 8Mod/Row	—	—	8	8GB9908FMDTC	1/5
	MDB for Flexi DB, 12Mod/Row	—	—	12	8GB9912FMDTC	1/5
	MDB for Flexi DB, 16Mod/Row	—	—	16	8GB9916FMDTC	1/5
	MDB for Bus DB	—	—	12	8GB99BUSMBTC	1/5
	MDB for Bus Plus DB	—	—	12	8GB99PLUSMBTC	1/5

### 3VT1 MCCB with thermal magnetic trip unit (overload and short circuit protection)

Breaking capacity, Icu = 25kA at 415V AC, 50Hz.

Standards: IS 13947-2 / IEC 60947-2

“with CE marking”

	Rated Current	3P Type Reference	4P Type Reference
	63A	3VT17062DA360AA0	3VT17062EA460AA0
	80A	3VT17082DA360AA0	3VT17082EA460AA0
	100A	3VT17102DA360AA0	3VT17102EA460AA0
	125A	3VT17122DA360AA0	3VT17122EA460AA0
	160A	3VT17162DA360AA0	3VT17162EA460AA0

Note:

■ Stock Items







# 1MW (Module Width) = 18mm

For insulated shorting links for Betagard Distribution Boards, please refer page 8.

# Betagard Distributions Boards

## Betagard 8GB31 DBs

### Accessories

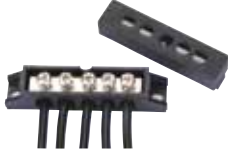
	Item Description	Reference No	Std. Pkg. (Nos.)
<b>Blanking Plate</b>			
	1 MW	8GB9901	25
	1.5 MW	8GB9902	25
<b>Insulated Shorting Links</b>			
<b>Suitable For SPN and TPN PPI DBs</b>			
	5 Leg SP Shorting Link (For 4 Way SPN DB and 4 Way PPI DB)	8GB9905LSP	10
	7 Leg SP Shorting Link (For 6 Way SPN DB and 6 Way PPI DB)	8GB9907LSP	10
	9 Leg SP Shorting Link (For 8 Way SPN DB and 8 Way PPI DB)	8GB9909LSP	10
	11 Leg SP Shorting Link (For 10 Way SPN DB and 10 Way PPI DB)	8GB9911LSP	10
	13 Leg SP Shorting Link (For 12 Way SPN DB and 12 Way PPI DB)	8GB9913LSP	10
	15 Leg SP Shorting Link (For 14 Way SPN DB and 14 Way PPI DB)	8GB9915LSP	10
	17 Leg SP Shorting Link (For 16 Way SPN DB and 16 Way PPI DB)	8GB9917LSP	10
<b>Single Phase (Hole at last Tooth) (For shorting 1P MCBs in TPN DBs)</b>			
	4 Leg SP Shorting Link (For 4 Way TPN DB)	8GB9904LSP	10
	6 Leg SP Shorting Link (For 6 Way TPN DB)	8GB9906LSP	10
	8 Leg SP Shorting Link (For 8 Way TPN DB)	8GB9908LSP	10
	10 Leg SP Shorting Link (For 10 Way TPN DB)	8GB9910LSP	10
	12 Leg SP Shorting Link (For 12 Way TPN DB)	8GB9912LSP	10
	14 Leg SP Shorting Link (For 14 Way TPN DB)	8GB9914LSP	10
16 Leg SP Shorting Link (For 16 Way TPN DB)	8GB9916LSP	10	
<b>Two Phase (For shorting 2P MCBs)</b>			
	4 Way DP Shorting Link (For Shorting 4 Nos of 2P MCBs)	8GB9904LDP	5
	6 Way DP Shorting Link (For Shorting 6 Nos of 2P MCBs)	8GB9906LDP	5
	8 Way DP Shorting Link (For Shorting 8 Nos of 2P MCBs)	8GB9908LDP	5
<b>Three Phase (For shorting 3P MCBs)</b>			
	4 Way TP Shorting Link (For Shorting 4 Nos of 3P MCBs)	8GB9904LTP	5
	6 Way TP Shorting Link (For Shorting 6 Nos of 3P MCBs)	8GB9906LTP	5
	8 Way TP Shorting Link (For Shorting 8 Nos of 3P MCBs)	8GB9908LTP	5
<b>Three Phase Neutral</b>			
	4 Way TPN Shorting Link (For Shorting 4 Nos of 4P MCBs)	8GB9904LTPN	5
	6 Way TPN Shorting Link (For Shorting 6 Nos of 4P MCBs)	8GB9906LTPN	5
	8 Way TPN Shorting Link (For Shorting 8 Nos of 4P MCBs)	8GB9908LTPN	5
<b>Neutral Terminals</b>			
<b>Neutral Terminals For 8GB31 DBs</b>			
	Neutral Terminals for 4 Way Circuits	8GB9904NSPE	10
	Neutral Terminals for 6 Way Circuits	8GB9906NSPE	10
	Neutral Terminals for 8 Way Circuits	8GB9908NSPE	10
	Neutral Terminals for 12 Way Circuits	8GB9912NSPE	10
	Neutral Terminals for 14 Way Circuits	8GB9914NSPE	10
<b>Neutral Terminals For 8GB32 DBs (With Terminal Shroud and Cover)</b>			
	Neutral Terminal 5 Holes	8GB9905NPE	10
	Neutral Terminal 11 Holes	8GB9911NPE	10
	Neutral Terminal 13 Holes	8GB9913NPE	10
	Neutral Terminal 15 Holes	8GB9915NPE	10

Note: # Way - Denotes No of MCBs at the Outgoing

### Dimensional drawings:

#### Betagard MB

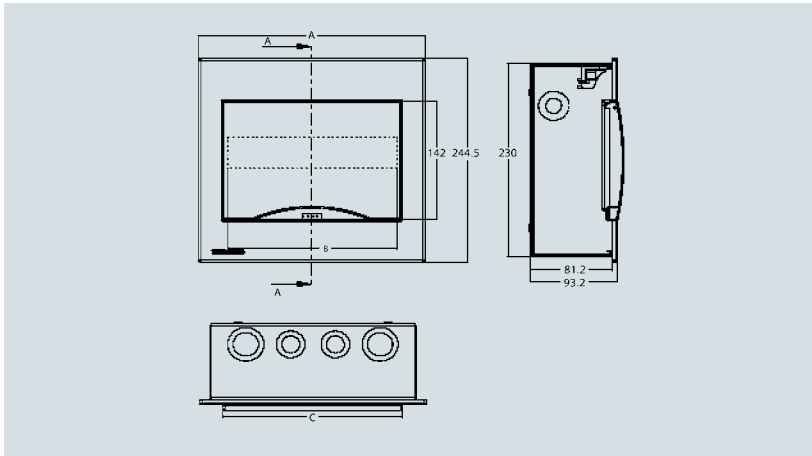

Model	A	B	C	Knock out Per side (Top & Bottom)	
				Ø32	Ø40
8GB31810RC..	253	108	200	2	2
8GB31811RC..		144			
8GB31812RC..	325	180	272	3	2
8GB31813RC..		216			
8GB31814RC..	397	252	344	5	2
8GB31815RC..		288			



# Betagard Distributions Boards

## Betagard 8GB31 DBs

### Dimensional drawings:

#### Beta Flex DB (8GB31) - 2 rows system

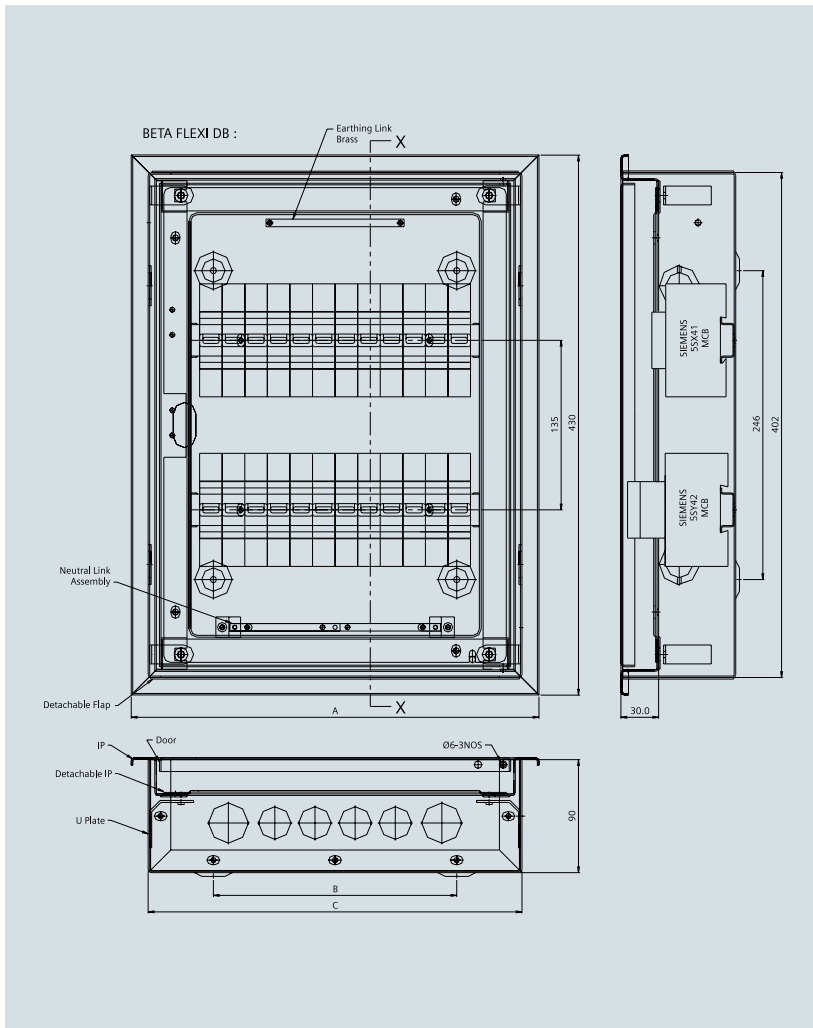

#### Note:

- 1) Powder coating  $100\pm 25\mu$
- 2) Colour ivory white RAL-9016 shade
- 3) All dimensions are in mm.

#### Dimension (mm)

Model	A	B	C	Knockout		
				Per side (top & bottom)		Per side flap combination Ø32/Ø21 combi
				Combi Ø40/Ø28	Combi Ø32/Ø20	
12 x 2 Rows	345	194	318	2	3	2
16 x 2 Rows	433	282	406		5	

**Application:** Recommended for residential and commercial buildings where-in mounting of modular devices like timers, ammeters, and TP MCBs are to be connected in the outgoing circuits.

### Dimensional drawings:

#### Beta Flex DB (8GB31) - 4 rows system

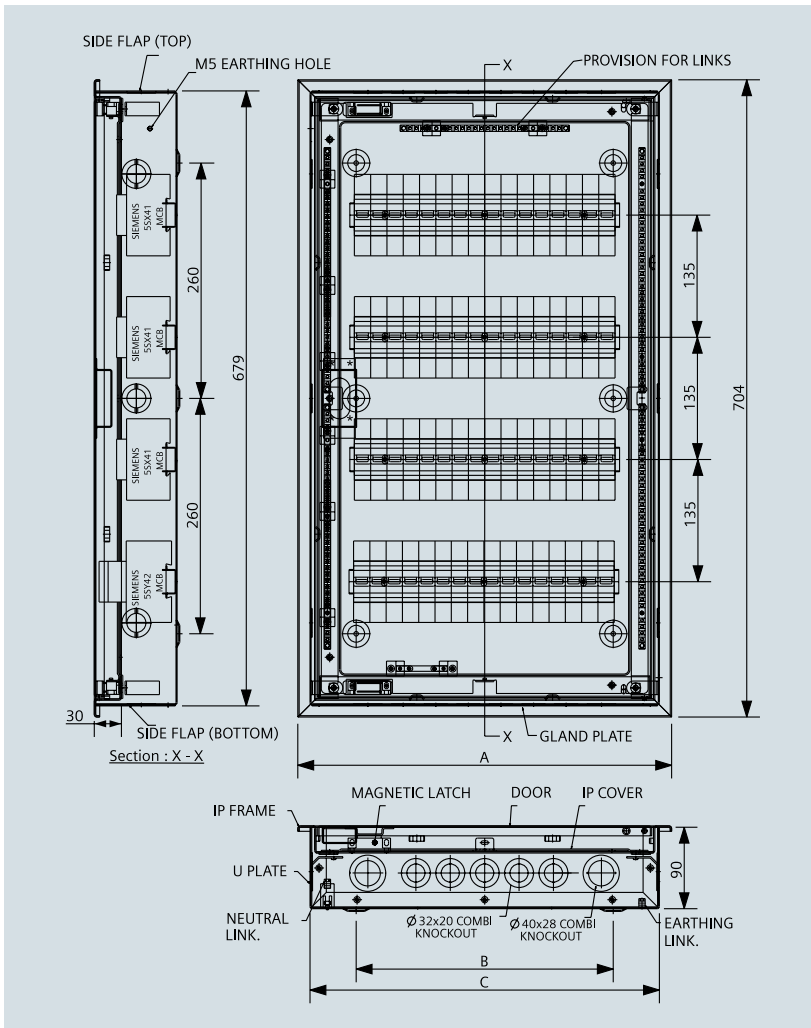

**Note:**

- 1) Powder coating 100±25µ
- 2) Colour ivory white RAL-9016 shade
- 3) All dimensions are in mm.

#### Dimension (mm)

Model	A	B	C	Knockout		
				Per side (top & bottom)		Per side flap combination Ø32/Ø21 combi
				Combi Ø40/Ø28	Combi Ø32/Ø20	
8 x 4 Rows	273	124	246	2	1	3
12 x 4 Rows	345	196	318		3	
16 x 4 Rows	433	284	406		5	

**Application:** Highly recommended for commercial buildings where-in the total number of circuits are considerably more. Beta flex can offer 16 module X 4 rows design DB which can accommodate 64 modules in total of 55/70mm depth.

# Betagard Distributions Boards

## Betagard 8GB31 DBs

### Dimensional drawings:

#### Beta Bus DB (8GB31)

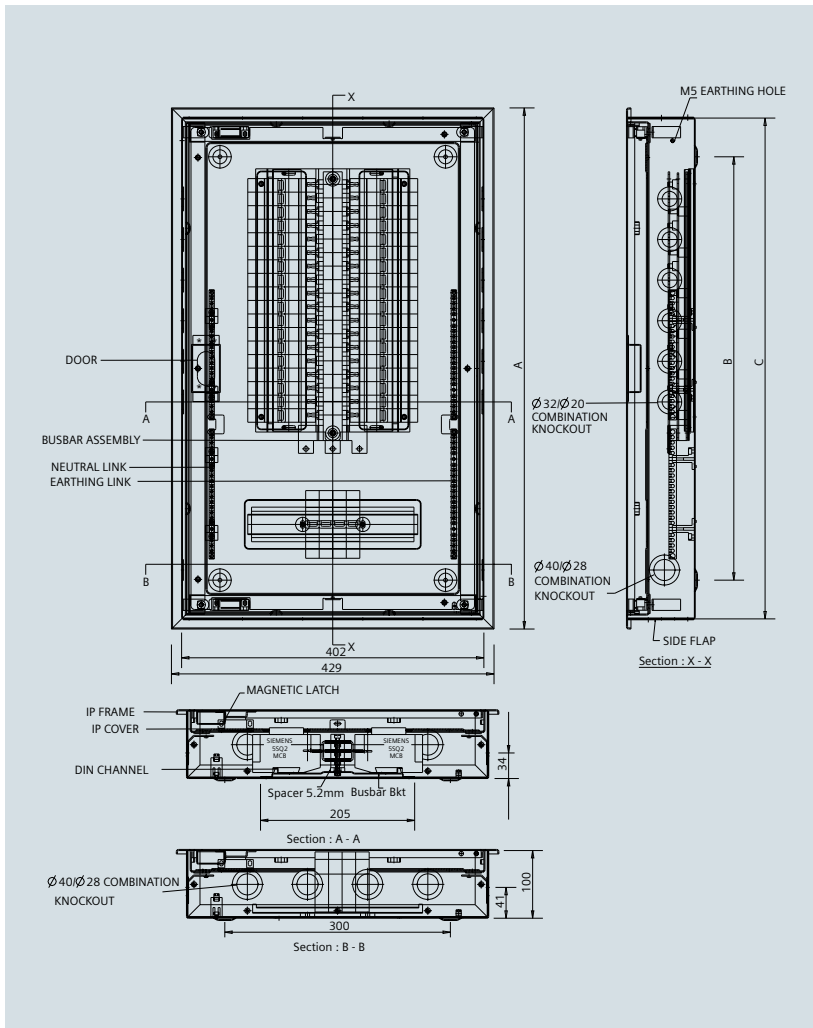

**Note:**

- 1) Powder coating 100±25µ
- 2) Colour ivory white RAL-9016 shade
- 3) All dimensions are in mm.

#### Dimension (mm)

Model	A	B	C	Knockout			
				Top & bottom combination Ø42 & Ø35	Bottom slit	Per side flap combination Ø32 & Ø20	Per side flap combination Ø40 & Ø28
4 Way	477	347	450	4	72 X 46	2	1
6 Way	531	401	504		72 X 46	3	
8 Way	585	455	558	4	72 X 46	4	1
12 Way	693	563	666		72 X 46	6	

**Application:** Recommended where ever TP/SP MCBS are to be mounted in the outgoing circuits. The ready made insulated vertical bus bar will simplify the wiring job apart from giving total safety.



### Dimensional drawings:

#### Beta Bus plus DB with verical Bus Bar (8GB31)

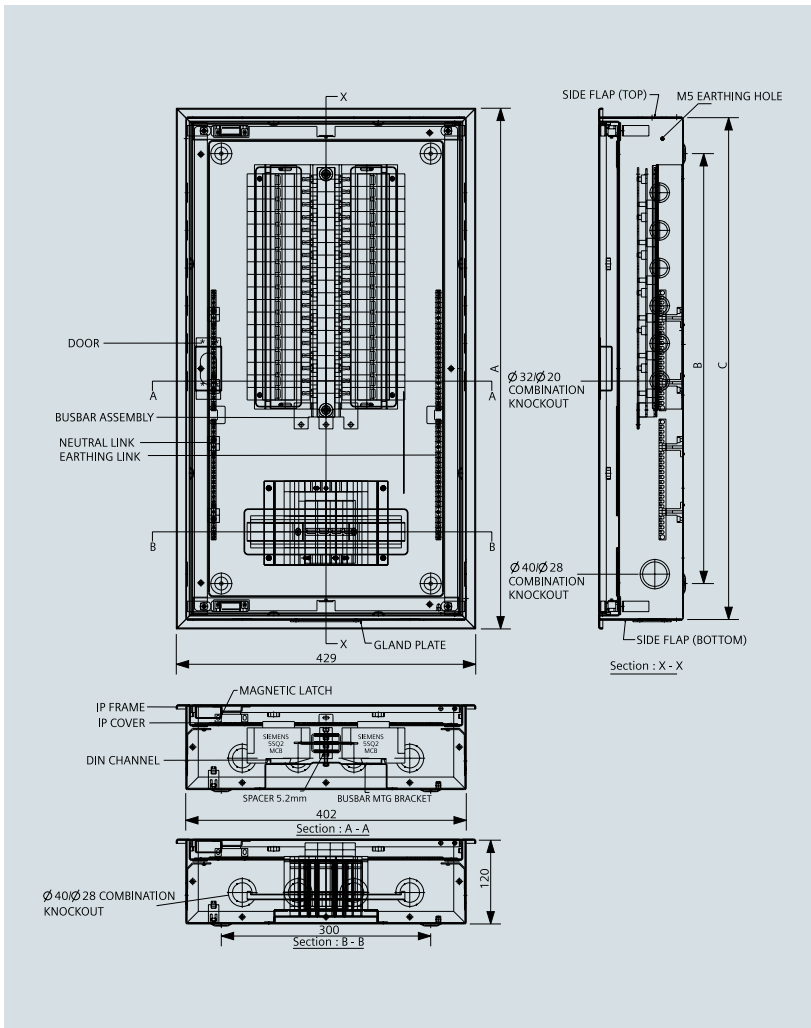

**Note:**

- 1) Powder coating 100±25µ
- 2) Colour ivory white RAL-9016 shade
- 3) All dimensions are in mm.

**Dimension (mm)**

Model	A	B	C	Knockout			
				Top & bottom combination Ø40/Ø28 (with gland plate)	Bottom slit	Per side flap combination Ø32/Ø20	Per side flap combination Ø40/Ø28
4 Way	530	400	503	4 / 2	72 X 46	2	1
6 Way	584	454	557		72 X 46	3	
8 Way	638	508	611		72 X 46	4	
12 Way	746	616	719	4 / 2	72 X 46	6	1

**Application:** Highly Recommended where ever MCCB as incomer up to 160A and TP/SP MCBS are to be mounted in the outgoing circuits. The ready made insulated vertical bus bar will simplify the wiring job apart from giving total safety.

# Betagard Distributions Boards

## Betagard 8GB31 DBs

### Dimensional drawings:

#### Betagard SPN DB (8GB31) with or without TV splitter and krone type telephone socket

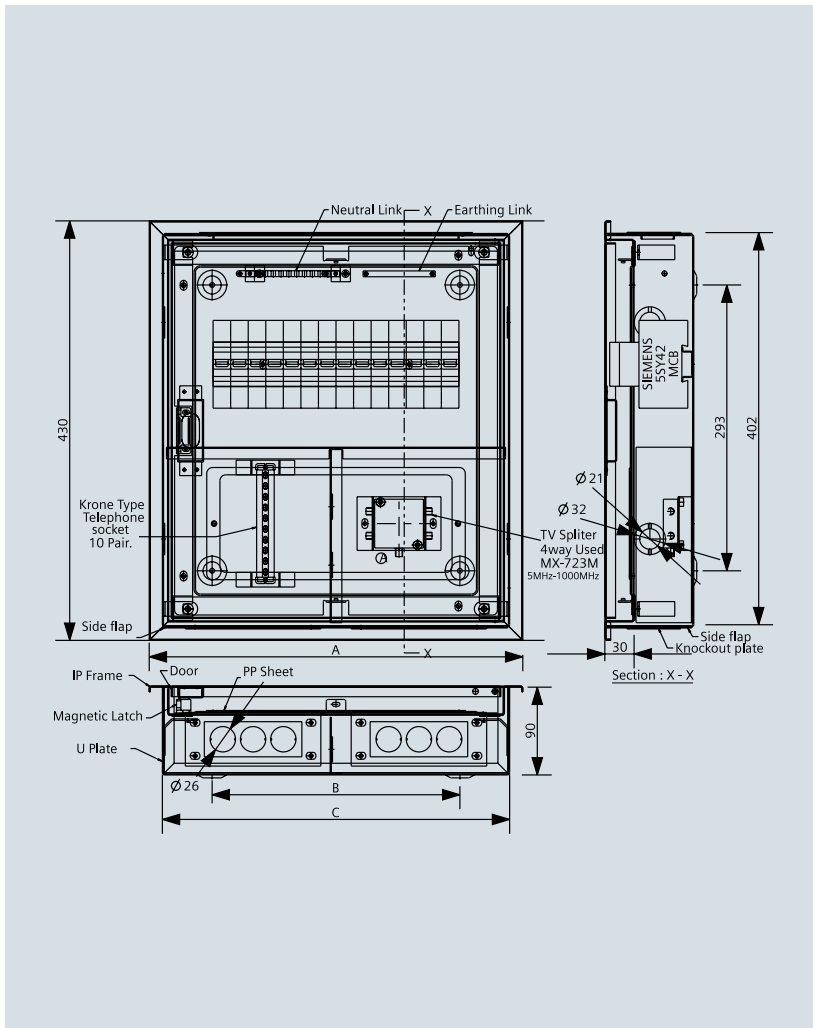

**Note:**

- 1) Powder coating  $100\pm 25\mu$
- 2) Colour ivory white RAL-9016 shade
- 3) All dimensions are in mm.

**Dimension (mm)**

Model	A	B	C	Knockout		
				Per side (top & bottom)		Per side flap combination $\varnothing 32/\varnothing 21$ combi
				Combi $\varnothing 40/\varnothing 28$	Combi $\varnothing 32/\varnothing 20$	
8GB31215RC	383	254	356	2	11	2
8GB31315RC						

**Application:** Recommended for single phase power distribution network + TV & telephone connection in one location in order to give better aesthetics and neat wiring.

### Dimensional drawings:

#### Betagard TPN DB (8GB31) with or without TV splitter and krone type telephone socket

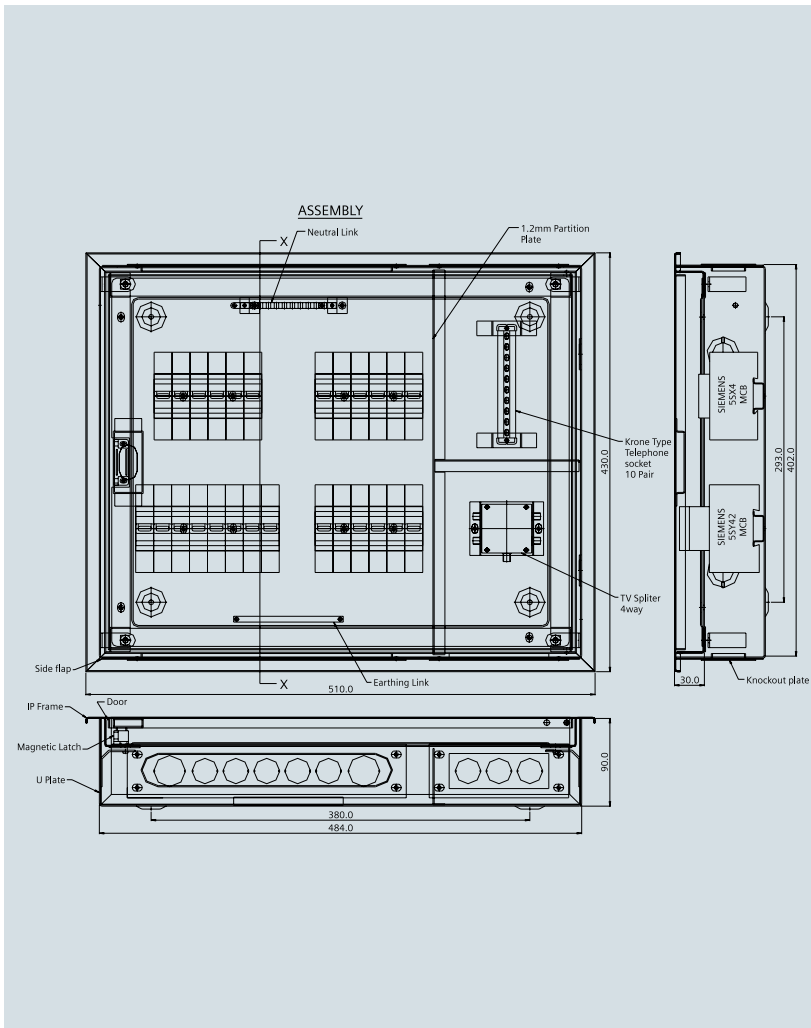

**Note:**

- 1) Powder coating 100±25µ
- 2) Colour ivory white RAL-9016 shade
- 3) All dimensions are in mm.

#### Dimension (mm)

Model	A	B	C	Knockout		
				Per side (top & bottom)		Per side flap size Ø32 & Ø21 combination
				Ø32	Ø26	
8GB31221RC	510	380	484	2	8	2
8GB31321RC						

**Application:** Recommended for three phase power distribution network + TV & telephone connection in one location in order to give better aesthetics and neat wiring.

# Betagard Distributions Boards

## Betagard 8GB31 DBs

### Dimensional drawings:

#### Beta phase change over DB (8GB31)

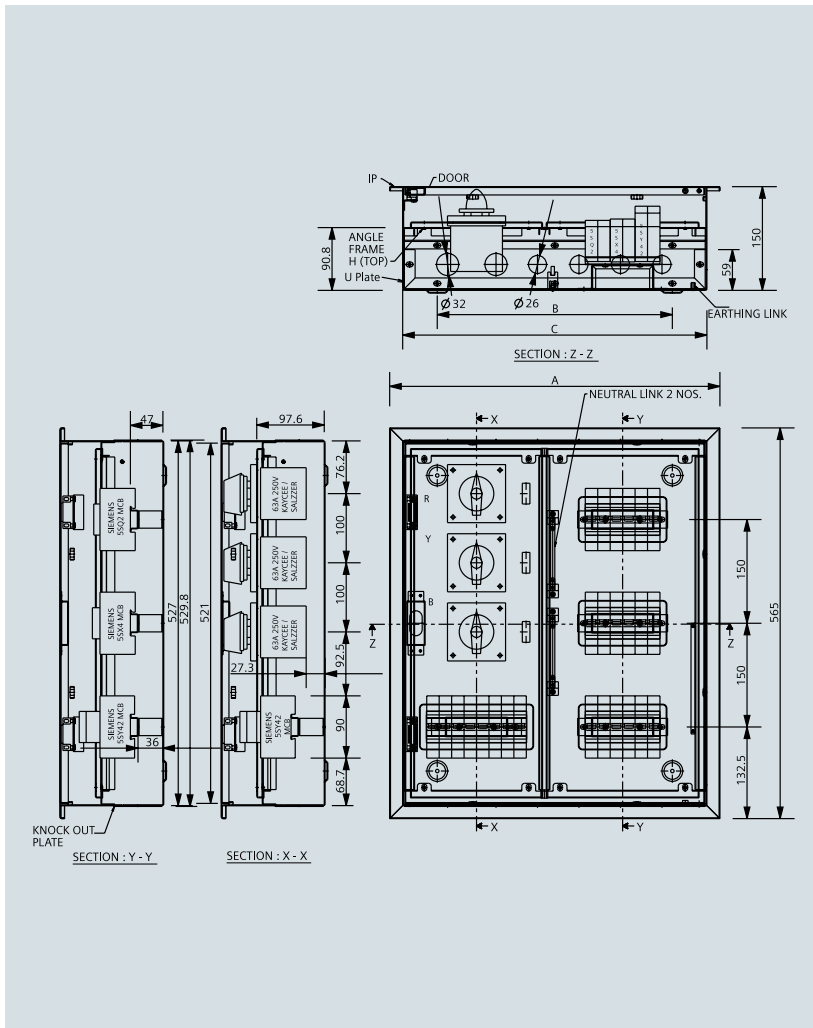

Note:

- 1) Powder coating  $100\pm 25\mu$
- 2) Colour ivory white RAL-9016 shade
- 3) All dimensions are in mm.

MLFB	Type	A	B	C
8GB3184 0RC	4 way	442	313	415
8GB3184 1RC	6 way	477	348	450
8GB3184 2RC	8 way	512	383	485
8GB3184 4RC	12 way	587	458	560

**Application:** Recommended where ever the reliability of 3 phase supplies are not dependable. Beta change over DB will have a feature to shift the load connected to the dead phase to a live one whenever there is a failure of any one phase.

### Dimensional drawings:

#### Beta Bus plus DB with vertical Bus Bar (8GB31)

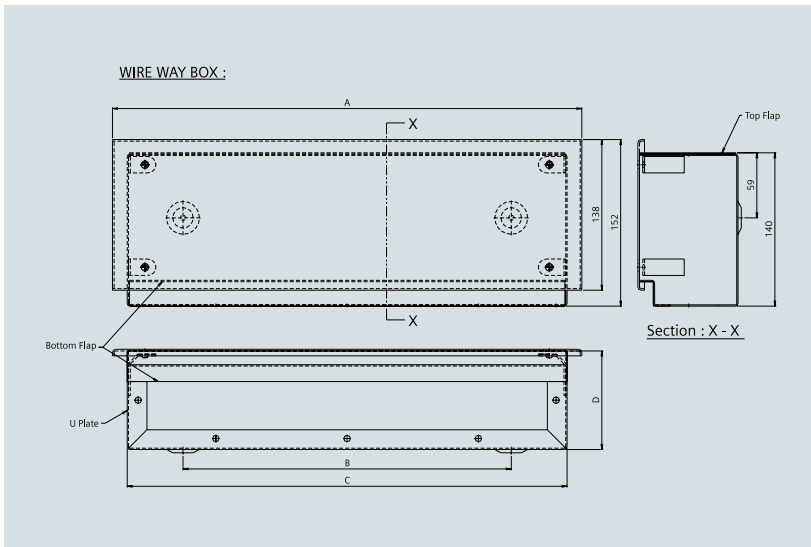

**Note:**

- 1) Powder coating 100±25µ
- 2) Colour ivory white RAL-9016 shade
- 3) All dimensions are in mm.

Suitable for	Config.	Type	A	B	C	D	Nos of MCB Slot
Flexi DB	12 X 2R & 12 X 4R	8GB9912FWWNT	325	226	298	90	12
	8 X 4R	8GB9908FWWNT	253	154	226		08
	16 X 2R & 16 X 4R	8GB9916FWWNT	413	314	386		16
Beta Bus DB	—	8GB99BUSWWNT	430	300	402	90	12
Beta Bus Plus DB	—	8GB99PLUSWWNT				120	

#### Betagard modular device boxes

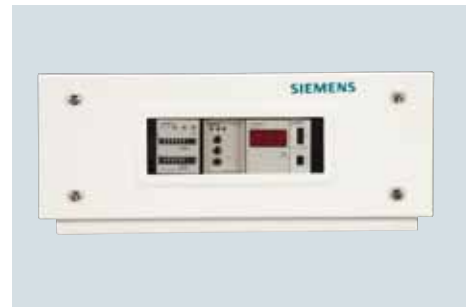
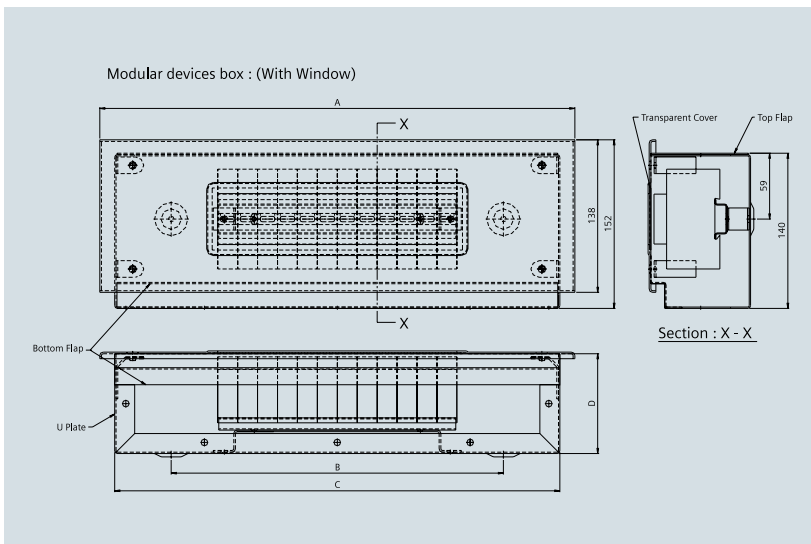

**Note:**

- 1) Powder coating 100±25µ
- 2) Colour ivory white RAL-9016 shade
- 3) All dimensions are in mm.

Suitable for	Config.	Type	A	B	C	D	Nos of MCB slot
Flexi DB	12 X 2R & 12 X 4R	8GB9912FMDTC	325	226	298	90	12
	8 X 4R	8GB9908FMDTC	253	154	226		08
	16 X 2R & 16 X 4R	8GB9916FMDTC	413	314	386		16
Beta Bus DB	-	8GB99BUSMBTC	430	300	402	90	12
Beta Bus Plus DB	-	8GB99PLUSMBTC				120	

# Betagard Distributions Boards

## Betagard 8GB31 DBs

### Wiring Diagram:

#### Three Phase Incoming & TP/SP outgoing with vertical busbar system

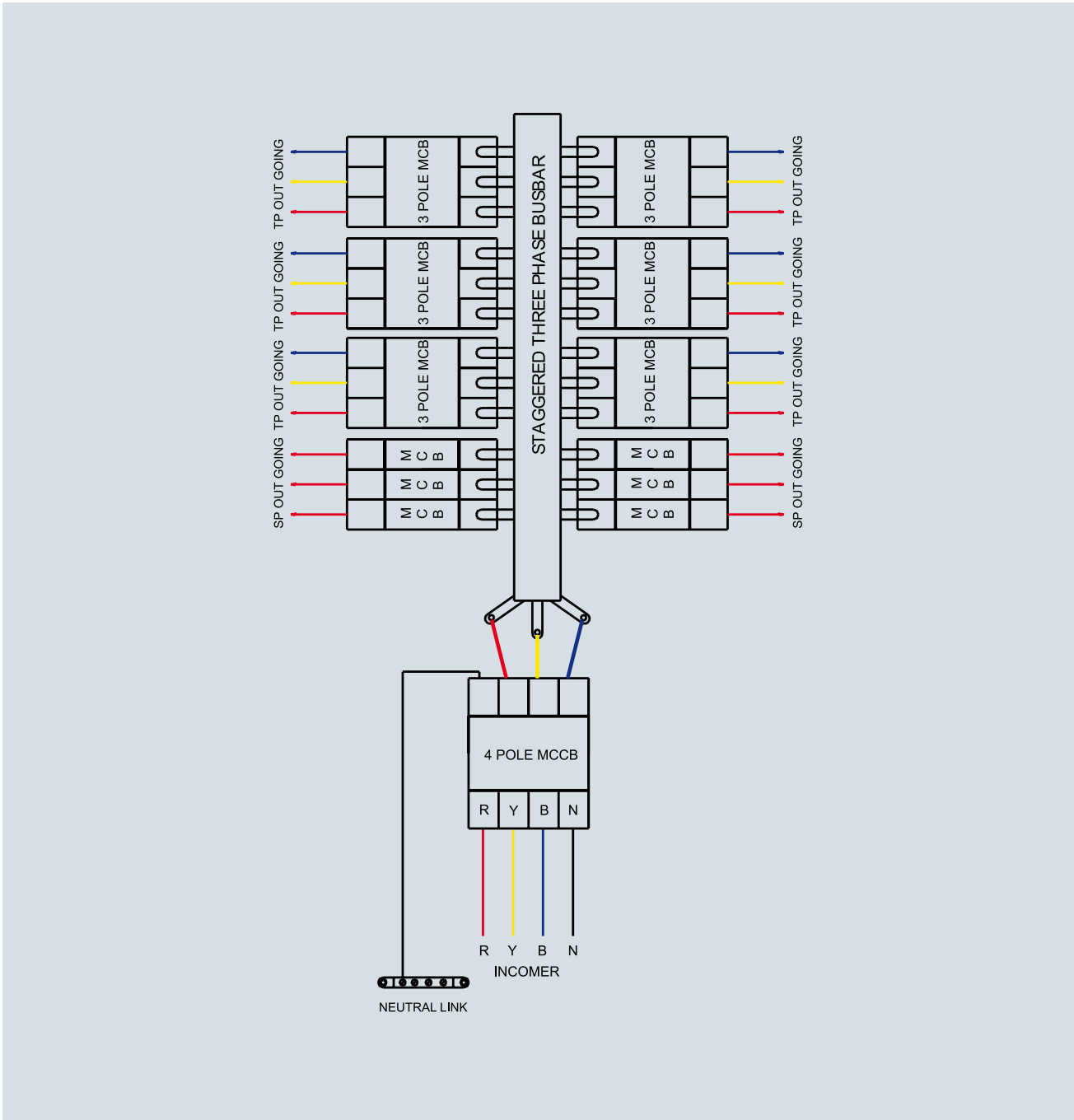

Beta Bus: 125A 5SP4, 63A 5SX4, 5SJ4 and 5SQ2 as an incomer and SP/TP MCB upto 63A 5SX4 and 5SQ2 as an outgoing  
Beta Bus Plus: 160A 3VT1 MCCB as incomer and SP/TP MCB upto 63A 5SX4 and 5SQ2 as outgoing

Simbox WP DBs are designed to withstand harsh ambient conditions in both indoor and outdoor areas and comply with IP 65. Their resistance to dust and splashing water makes them ideal for use in a range of different application areas, such as car washes, farms, joiners' workshops, etc.

Due to their large temperature operating range (-25°C to +60°C) UV radiation resistance and resistance to dust and splashing water, this distribution board range is especially suitable for harsh ambient conditions.

### Design:

#### Equipment

The distribution boards can be equipped with modular installation devices, such as MCBs and RCCBs with 63 A and a mounting depth of 55 mm up to 70 mm, by snapping onto the standard mounting rails 35 mm x 7.5 mm to EN 60715.

Depending on the selection, the small distribution boards can be equipped with devices of 12 to 18 modular widths.

### Technical specifications:

Rated current in A	Up to 63
Rated voltage in V AC	400
Degree of protection	IP65
Safety class	2 (total insulation)
Color	Light gray RAL 7035

### Standards:

The SIMBOX WP small distribution boards comply with EN 60439-3 and IEC 60439-3.

### Benefits:



- The wiring space behind the standard mounting rail is 15 mm and 48 mm, ensuring fast and easy wiring.
- The extremely robust transparent door can also be equipped with a lock, which can be ordered from the range of accessories. The door can be hinged on the right or left without tools; its opening angle is 180°.
- The withdraw able equipment rack ensures easy and fast assembly. The generous wiring space and clearly arranged modular design reduce assembly time by approx. 20%.
- The plastic materials used can be recycled.



# Betagard Distributions Boards

## SIMBOX WP

### Selection and Ordering Data:

	Item Description	Incoming Slots	Outgoing slots	Total slots	Reference No.	Std Pkg Nos.
<b>Simbox WP (IP65 DBs)</b>						
	1 Row, 4Mod	—	—	4	8GB13710	1
	1 Row 8Mod	—	—	8	8GB13711	1
	1 Row 12Mod	—	—	12	8GB13712	1
	1 Row 18Mod	—	—	18	8GB13713	1
	2 Row 2 x 12Mod	—	—	24	8GB13722	1
	2 Row, 2 x 18Mod	—	—	36	8GB13723	1
	3 Row, 3 x 18Mod	—	—	54	8GB13733	1
	4 Row 4 x 18Mod	—	—	72	8GB13743	1
<b>Accessories for Simbox WP</b>						
	Coupling covers,12M				8GB20510	1
	Coupling covers,18M				8GB20511	1
	Insulated N/PE terminals, 8MW				8GB20520	1
	Insulated N/PE terminals, 12MW				8GB20521	1
	Insulated N/PE terminals, 18MW				8GB20522	1
	Cylindrical security lock				8GB20550	1
	Interchangeable flange				8GB20500	1

Note:

- Stock Items # 1MW (Module Width) = 18mm





### Dimensional drawings:

#### Simbox WP

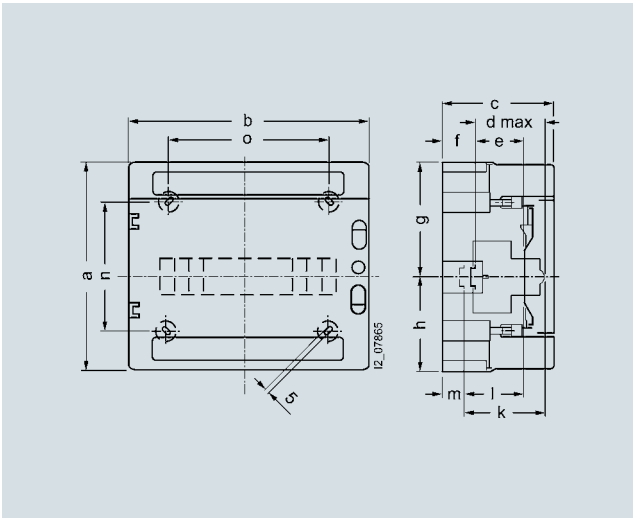

1-tier 8GB1 371-0, 8GB1 371-1, 8GB1 371-2, 8GB1 371-3

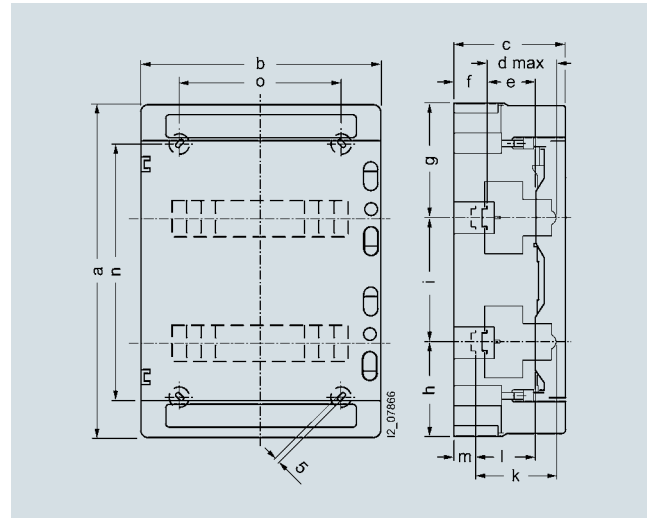

2-tier 8GB1 372-2, 8GB 372-3 (3- and 4-tier versions not shown)

MW	Type	Dimensions													
		a	b	c	d <sub>max</sub>	e	f	g	h	i	k	l	m	n	o
1 x 4	8GB1 371-0	210	148	100	75	48	15	105	105	-	-	-	-	156	87
1 x 8	8GB1 371-1		215											110	
1 x 12	8GB1 371-2	260	298	140	75	48	48	117.5	142.5	-	102	75	21	161	200
1 x 18	8GB1 371-3	285	410											185	310
2 x 12	8GB1 372-2	420	298	140	75	48	48	147.5	122.5	150	102	75	21	320	200
2 x 18	8GB1 372-3	463						410	155.5					131.5	210
3 x 18	8GB1 373-3	655	410	140	75	48	48	162.5	142.5	175	102	75	21	363	319
4 x 18	8GB1 374-3	878												160	

a = Distribution board height  
g = Device mounting depth

b = Distribution board width  
h = Wiring space behind the standard mounting rail

c = Distribution board depth



# Betagard Distributions Boards

Notes

# Betagard Automatic Transfer Switching Equipment - ATSE

**Power... When it matters the most!**



92 Betagard ATSE



# Betagard Automatic Transfer Switching Equipment - ATSE

## Betagard ATSE

### Overview & technical data

Back up power source has become an integral part of many industrial, commercial and domestic electrical power supply systems. Whenever there is a backup power source available, it is mandatory to have a change over switch which transfers the supply or source from the Mains to the Back up. Now a days to reduce the change over time, manual change over systems are getting replaced by the Automatic ones. That means Automatic Transfer Switching Equipments are becoming more and more prevalent.

Unlike the conventional ATSE ,the Siemens Betagard ATSEs, type 5TR has been designed and developed not only to take care during the unavailability of main supply but also to react to various power system problems. It has many useful features which make this product user friendly and highly reliable.

### Technical Details:

<b>Standards</b>	IS 60947-6
<b>Rated Voltage</b>	AC 240V/415V
<b>Rated Control voltage</b>	AC 240V
<b>Rated Current Range</b>	40A up to 125A
<b>No of poles</b>	DP and FP
<b>MCB Types</b>	C and D Characteristics
<b>Type</b>	Basic type 5TR1 Advanced type 5TR2
<b>Utilization Category</b>	AC 33B



## Principles of operation and features

### Principle of Operation and the Features:

- In the normal operating condition the MCB in the normal power side will be active. In the event of the power failure the ATSE mechanism gets the signal and changes over to the backup power source. Please note that the changeover will happen only when the back up power is up and available. In case the back-up power is not available the changeover will not happen. The same way once the main power resumes immediately the ATSE controller gives the signal and the MCB in the normal power side is turned on. The change over time i.e. total operating time is 1.5 to 2.5 seconds but depending on the application or requirement a deliberate delay can be introduced, that means changeover time could be increased up to 60 seconds at the maximum.
- In the event of a phase failure (any one of the phases) in the Normal Supply, the ATSE automatically switches to the back up source if the backup power is available. The same way the ATSE comes back to the original position once the normal power is restored.
- There is an option for MANUALLY changing from the Normal Source to the Backup source and the vice versa. With this option of manual operating of the ATSE, the load can be shifted either to the main or the backup supply depending upon the requirement.
- In the event of an overload or a short circuit the MCB internally trips and disconnects the supply. The Alarm goes ON in this condition indicating the fault. In this case the ATSE needs to be reset after rectification of the fault and again switched ON.
- In case of an emergency if a total shut down i.e. complete power cutoff from either of the sources is required; it is possible by applying a 24V DC input to the ATSE. This signal can be hooked from the Fire alarm system or any Building management system also.

Function	ATSE 5TR1	ATSE 5TR2
Controller Type	Basic Version	Advanced Type
Standard	IS 60947-6	
Rated Voltage	AC 240V/ 415V	
Rated Control Voltage	AC 240V	
Rated Current	40A, 63A, 100A & 125A	
Short Circuit Breaking Capacity	10kA	
MCB Characteristics	C & D Characteristics	
Utilization Category	AC 33B	
Adjustable Time Delay (Main to Backup Supply)	(Instantaneous) 0 - 60s	
Adjustable Time Delay (Back up to Main Supply)	(Instantaneous) 0 - 60s	
Operating/Changeover Time	1.5 - 2.5 s	
Time Delay for changeover	Simulation	Digital
Option of Automatic Changeover from Main to backup and Backup to main	Yes	Yes
Option of Automatic Changeover from Main to backup and manual changeover from Backup to main	Yes	Yes
Changeover during Under Voltage Situation (70-85% Ue)	No	Yes
Complete Off Position of ATSE (normal and backup power supply)	Yes	Yes
Alarm Indication incase of tripping (overload or short-circuit)	Yes	Yes
Contact Weld Indicator	Yes	Yes
Remote Controlled Emergency Shutdown	No	Yes
Option of giving signal to the generator for starting	No	Yes

# Betagard Automatic Transfer Switching Equipment - ATSE

## Betagard ATSE

### ATSE types

#### ATSE Operation: 5TR1 Basic Type

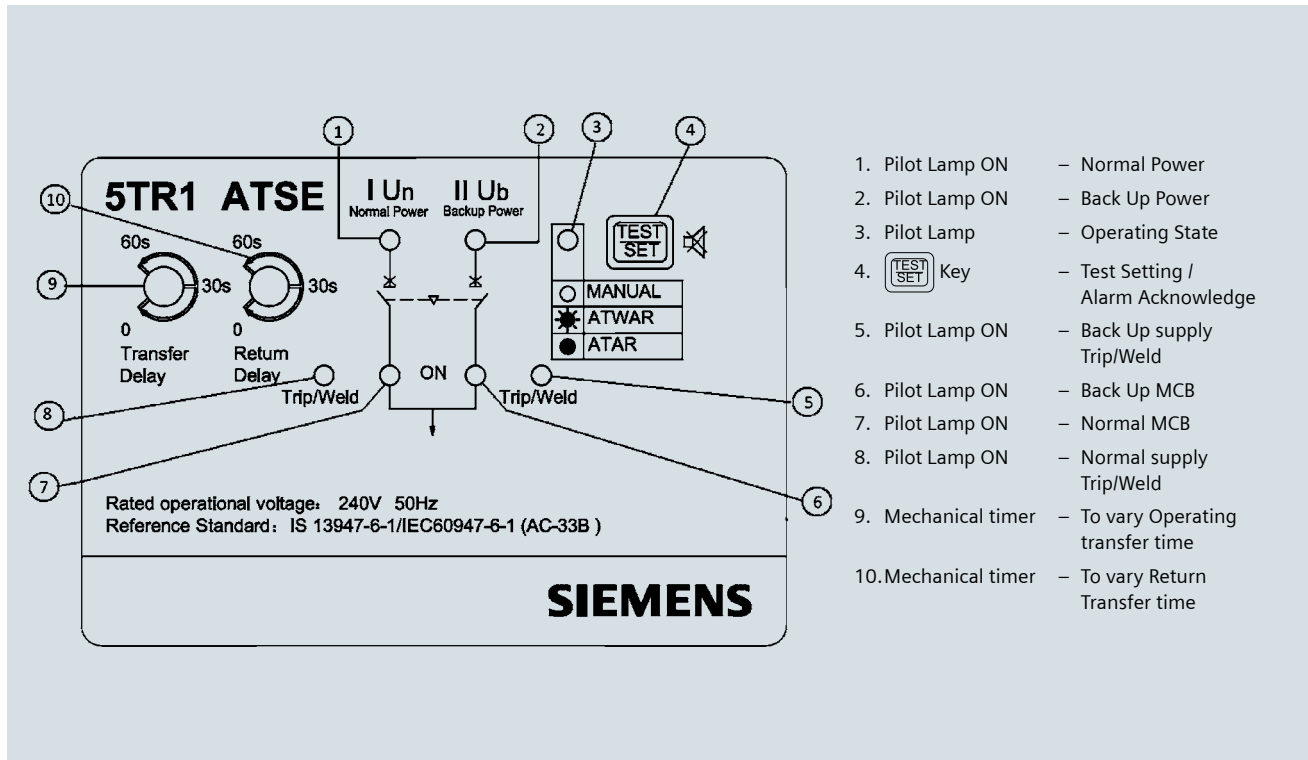

#### ATSE Operation: 5TR2 Advanced Type

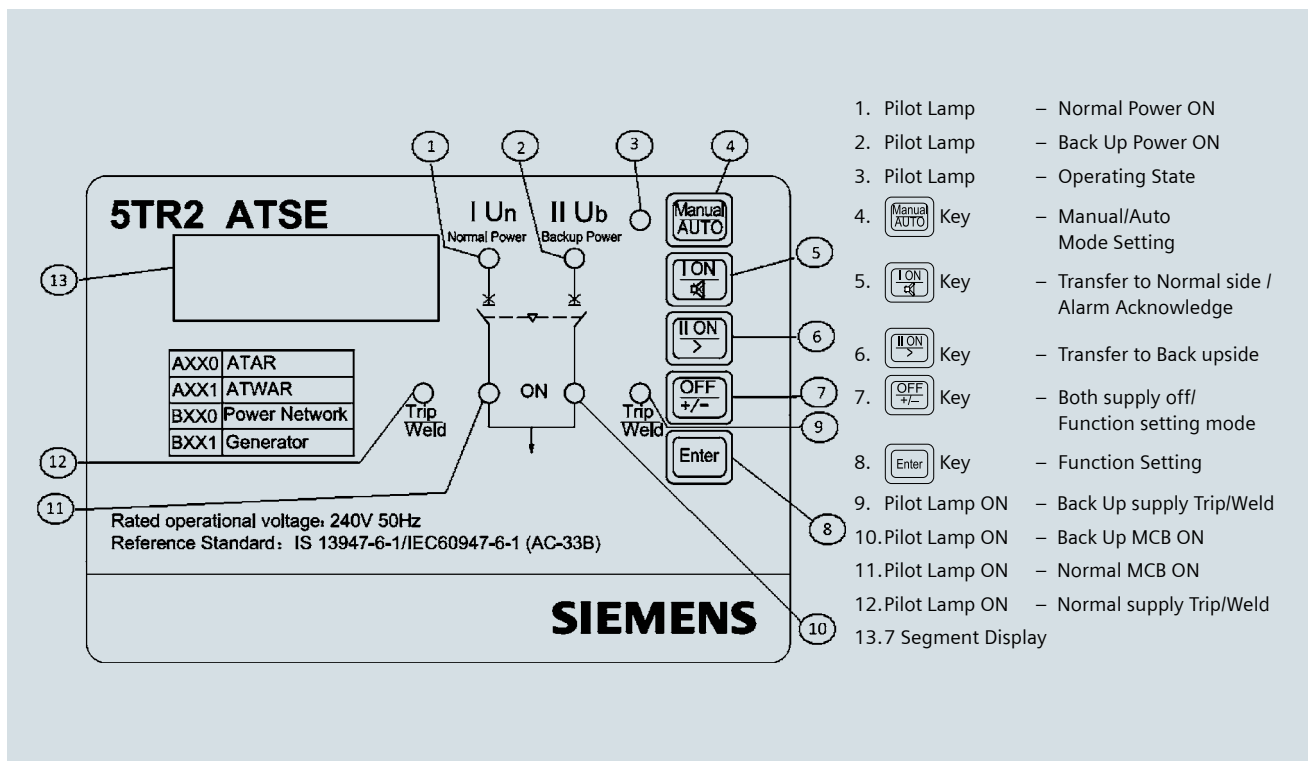

## Selection & ordering data

### Item Description and Part Numbers:

	No. of poles	ATSE Type	MCB Characteristics	Rated Current In (A)	Description	MLFB
	2 Pole	BASIC	C	100A	100 2P ATSE 'C' Curve-Basic Version	5TR13327RC81
				125A	125A 2P ATSE 'C' Curve-Basic Version	5TR13327RC82
	4 Pole	BASIC	C	100A	100A 4P ATSE 'C' Curve-Basic version	5TR13347RC81
				125A	125A 4P ATSE 'C' Curve-Basic version	5TR13347RC82
	2 Pole	BASIC	D	40A	40A 2P ATSE 'D' Curve-Basic Version	5TR13328RC40
				63A	63A 2P ATSE 'D' Curve-Basic Version	5TR13328RC63
				100A	100A 2P ATSE 'D' Curve-Basic Version	5TR13328RC81
	4 Pole	BASIC	D	40A	40A 4P ATSE 'D' Curve-Basic version	5TR13348RC40
				63A	63A 4P ATSE 'D' Curve-Basic version	5TR13348RC63
100A				100A 4P ATSE 'D' Curve-Basic version	5TR13348RC81	
	2 Pole	ADVANCED	C	100A	100 2P ATSE 'C' Curve-Advanced Version	5TR23327RC81
				125A	125A 2P ATSE 'C' Curve-Advanced Version	5TR23327RC82
	4 Pole	ADVANCED	C	100A	100A 4P ATSE 'C' Curve-Advanced Version	5TR23347RC81
				125A	125A 4P ATSE 'C' Curve-Advanced Version	5TR23347RC82
	2 Pole	ADVANCED	D	40A	40A 2P ATSE 'D' Curve-Advanced Version	5TR23328RC40
				63A	63A 2P ATSE 'D' Curve-Advanced Version	5TR23328RC63
				100A	100A 2P ATSE 'D' Curve-Advanced Version	5TR23328RC81
	4 Pole	ADVANCED	D	40A	40A 4P ATSE 'D' Curve-Advanced version	5TR23348RC40
				63A	63A 4P ATSE 'D' Curve-Advanced version	5TR23348RC63
				100A	100A 4P ATSE 'D' Curve-Advanced version	5TR23348RC81

### Benefits:

- Prewired solution provides ease in installation
- Features to ensure installation safety
- Key function parameters providing various options

### Applications:

- Common Area Lighting in residential Complexes and commercial Installations.
- Lift Back up Supply in the event of power failure in Residential Apartments and Societies.
- Small Commercial Establishments e.g. Shopping Complex etc
- Data Centre and Server room back up.
- Change over for Back up supply for individual Residences in Apartments and Bungalows.

# Betagard Automatic Transfer Switching Equipment - ATSE

## Betagard ATSE

### Dimensional details

The instruction and the control system wiring reference chart for 5TR1 and 5TR2 are mentioned below:

#### ATSE Basic Version 5TR1: Circuit Diagram

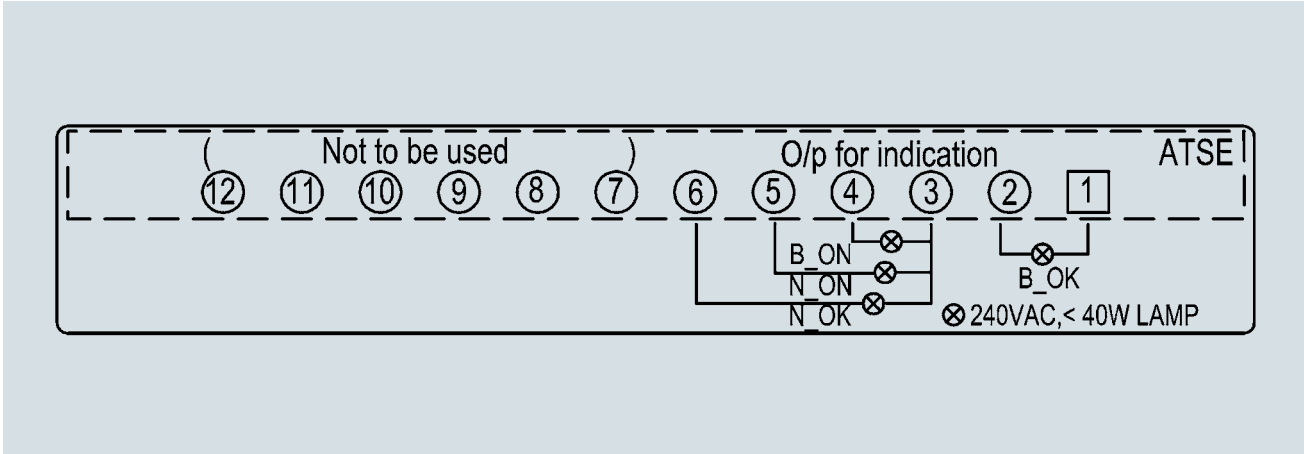

#### ATSE Advanced Version 5TR2: Circuit Diagram

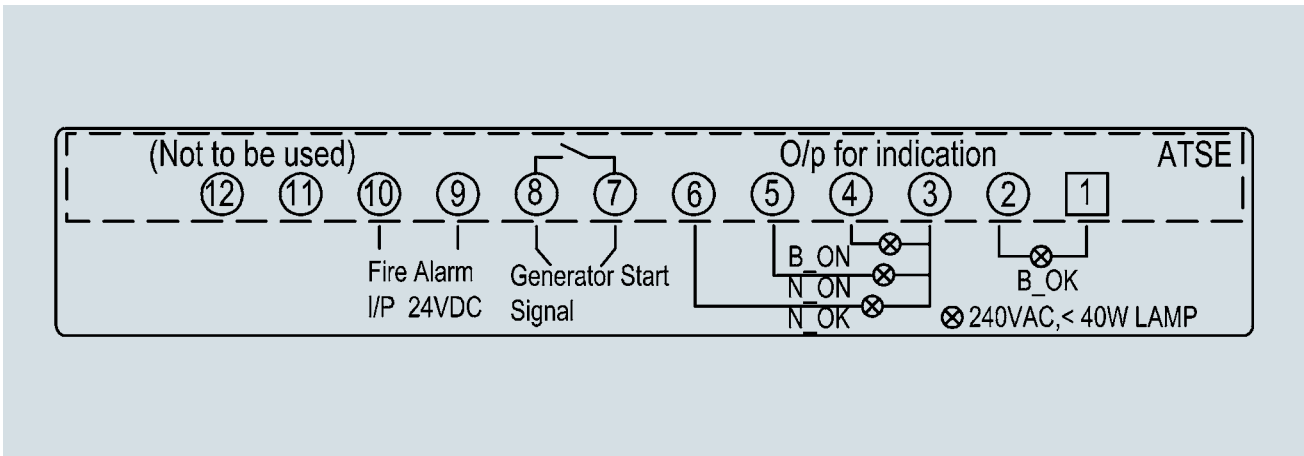



## Dimensional details

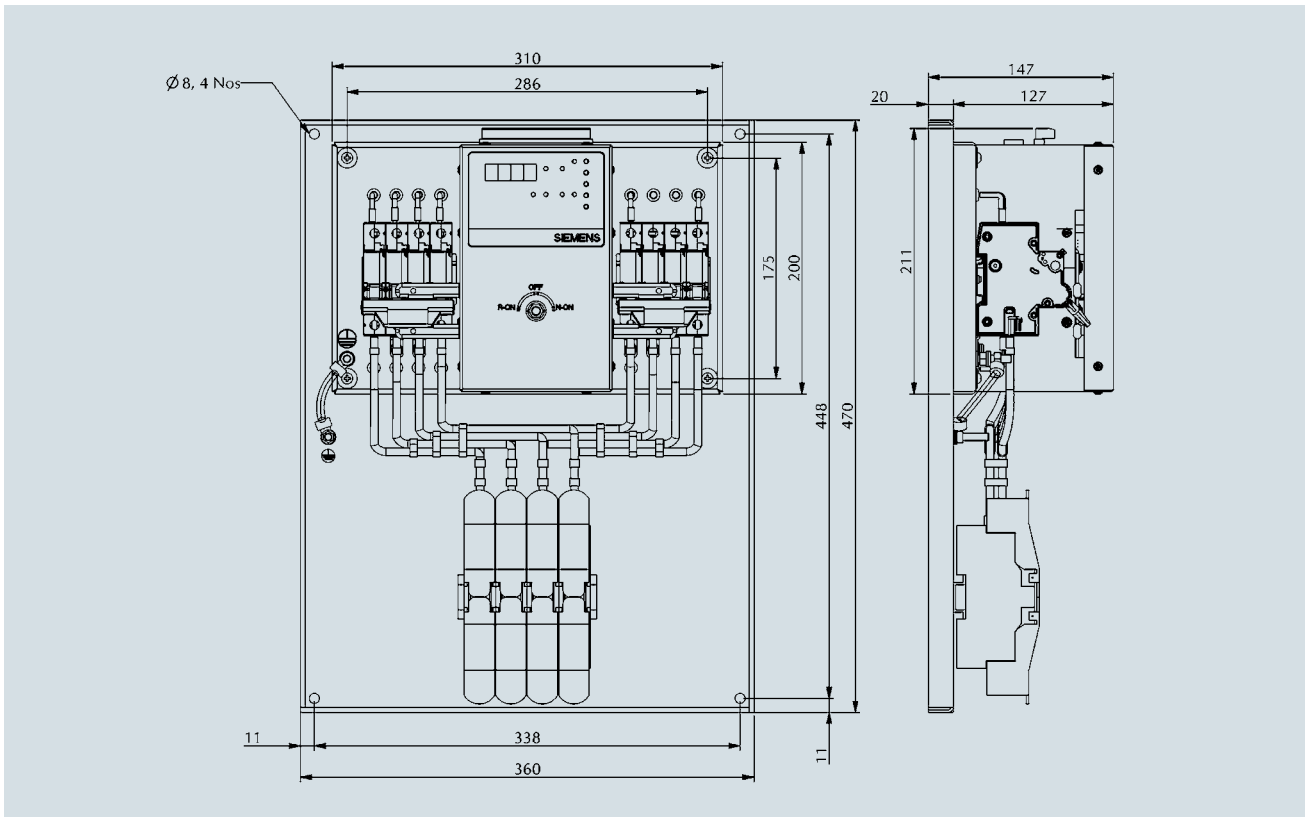

Figure 1: Outline dimension (5TR1 & 5TR2 with rated current up to 63A)

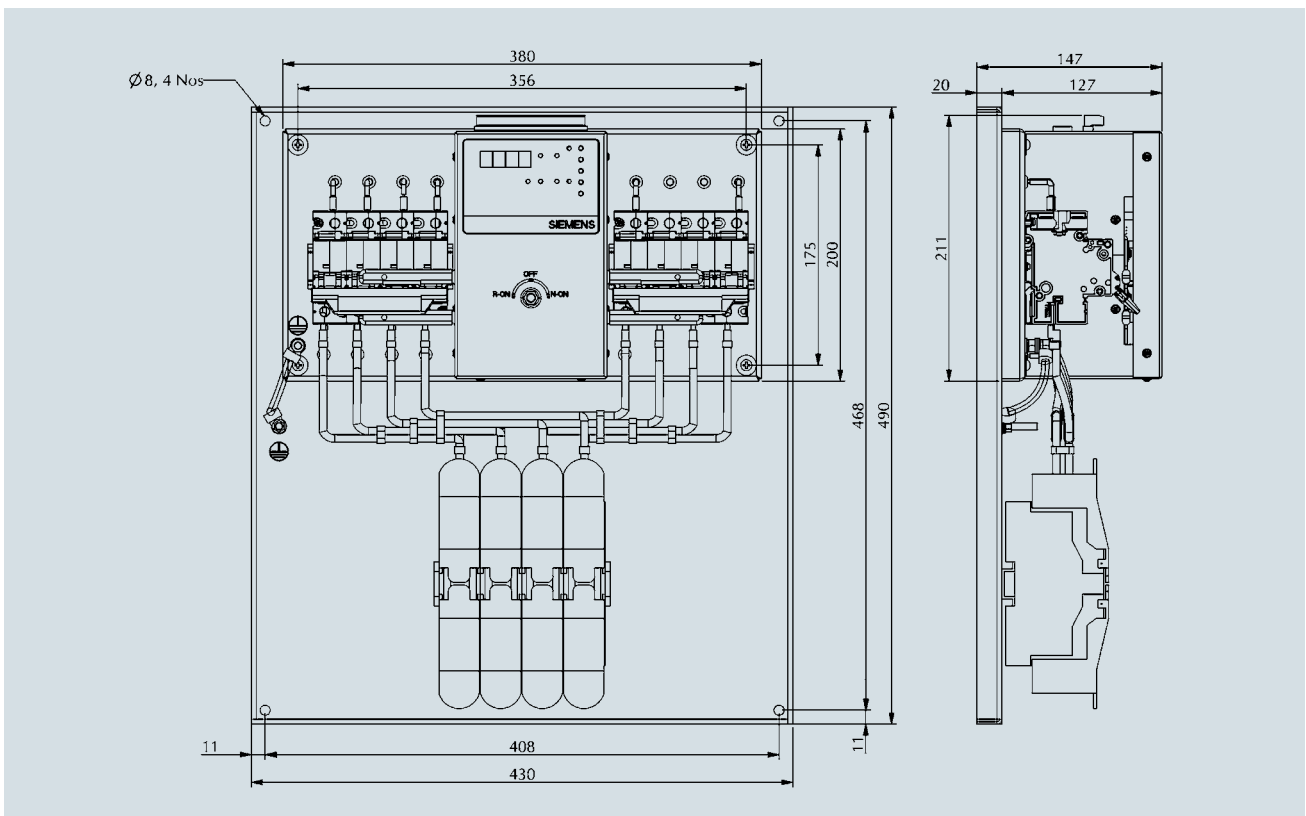

Figure 2: Outline dimension (5TR1 & 5TR2 with rated current 100A & 125 A)

# Betagard Automatic Transfer Switching Equipment - ATSE

## Betagard ATSE

### ATSE in a power distribution

#### Use of ATSE in an electrical power supply system

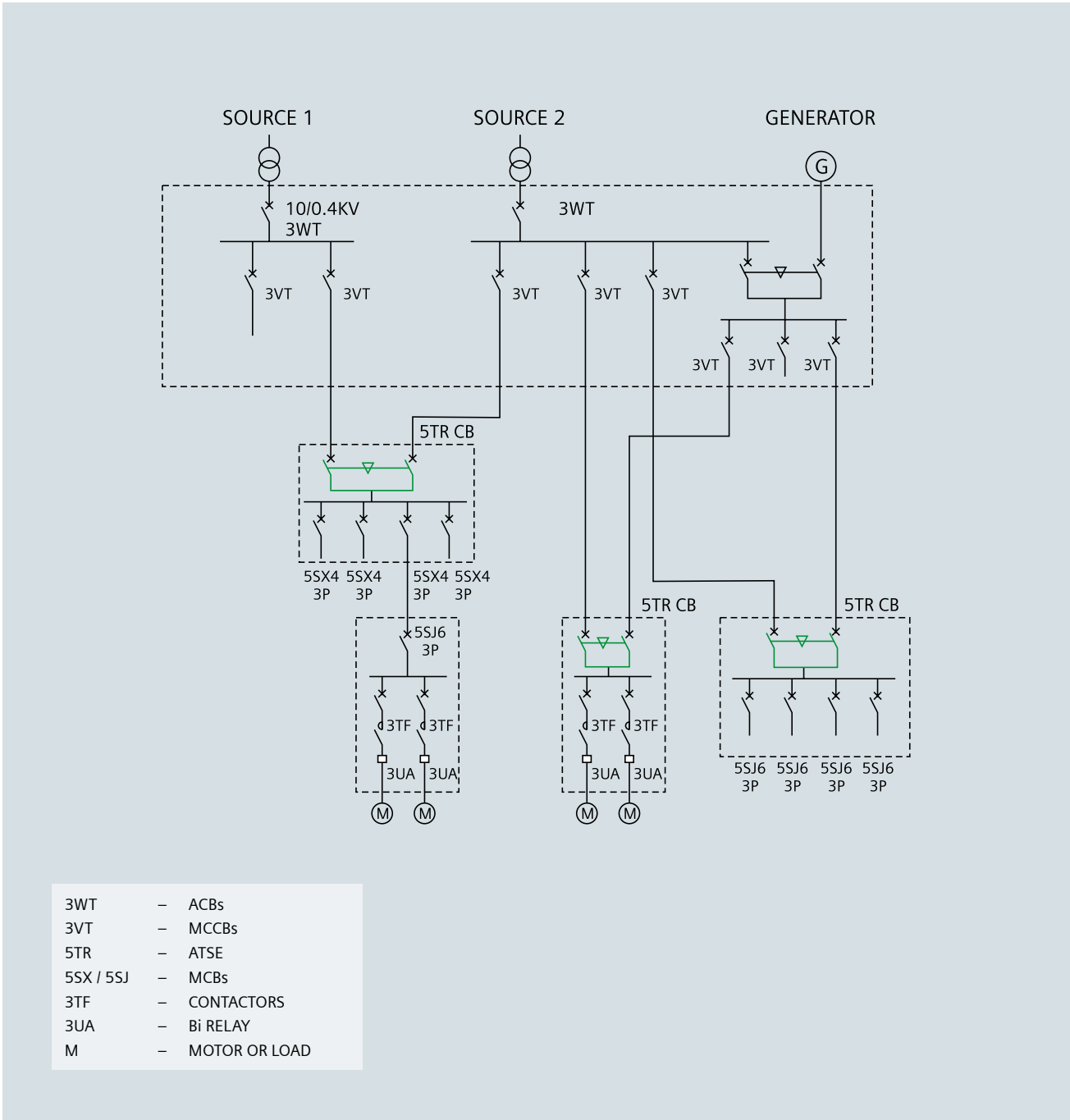

SIEMENS

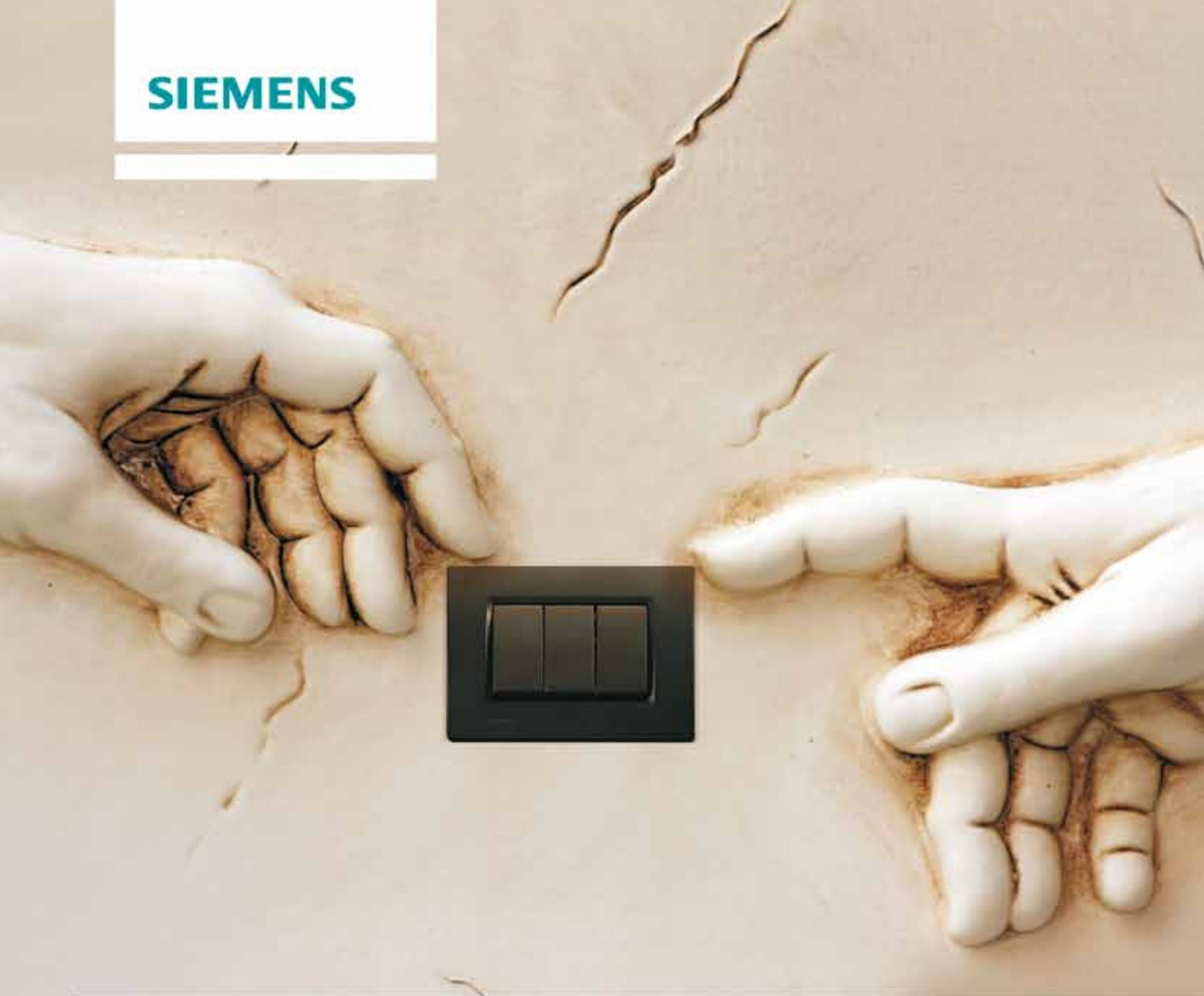

# Switch to elegance

DELTA vega Modular Switches

Answers for Infrastructure.

DELTA vega, an elegant range of modular switches and sockets from the house of Siemens, is a winner of the world famous RED DOT™ award for product design.

DELTA vega stands for design in its purest form and helps enhance your home decor with style and finesse.

For more details mail to: [switch.india@siemens.com](mailto:switch.india@siemens.com)



